

GCSE MATHS

Aiming for Grade 3

REVISION BOOKLET



2018 Exam Dates:

24th May 2018

7th June 2018

12th June at 2018

Name: _____

Contents

	Page:
Number:	
HCF and LCM	3
Laws of indices	7
Rounding	9
BIDMAS	10
Algebra:	
nth term	12
Sketching linear graphs	15
Expanding and factorising (single brackets)	23
Solving linear equations	25
Solving linear inequalities	28
Substituting	30
Shape, Space and Measure:	
Angles in parallel lines	33
Constructing triangles	39
Bearings	41
Transformations	45
Area and circumference of circles	50
Area problems	52
Volume and surface area of prisms	58
Speed, distance and time	62
Data Handling:	
Averages problems	65
Scatter graphs	69
Probability:	
Relative frequency	75
Ratio and Proportion:	
Dividing into a ratio	78
Recipes	81
Percentages of amounts, increasing and decreasing	84
Fractions, decimals and percentages	88

HCF and LCM

Things to remember:

- A factor is a whole number that divides exactly into another number.
- A multiple is a number that may be divided by another a certain number of times without a remainder.
- A prime number only has 2 factors – 1 and itself.
- HCF is an abbreviation of Highest Common Factor and LCM of Lowest Common Multiple.

Questions:

1. Tom and Amy set the alarms on their phones to sound at 6.45 am.
Both alarms sound together at 6.45 am.
Tom's alarm then sounds every 9 minutes.
Amy's alarm then sounds every 12 minutes.
At what time will both alarms next sound together?

.....
(Total for question = 3 marks)

2. Caroline is making some table decorations.
Each decoration is made from a candle and a holder.
Caroline buys some candles and some holders each in packs.
There are 30 candles in a pack of candles.
There are 18 holders in a pack of holders.
Caroline buys exactly the same number of candles and holders.
(i) How many packs of candles and how many packs of holders does Caroline buy?

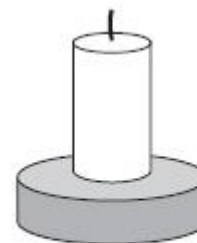

candle and holder

..... packs of candles

..... packs of holders

Caroline uses all her candles and all her holders.

- (ii) How many table decorations does Caroline make?

..... table decorations
(Total for question = 5 marks)

3. Buses to Acton leave a bus station every 24 minutes.
Buses to Barton leave the same bus station every 20 minutes.
A bus to Acton and a bus to Barton both leave the bus station at 9 00 am.
When will a bus to Acton and a bus to Barton next leave the bus station at the same time?

.....
(Total for Question is 3 marks)

4. Rita is going to make some cheeseburgers for a party.
She buys some packets of cheese slices and some boxes of burgers.
There are 20 cheese slices in each packet.
There are 12 burgers in each box.
Rita buys exactly the same number of cheese slices and burgers.
(i) How many packets of cheese slices and how many boxes of burgers does she buy?

..... packets of cheese slices

..... boxes of burgers

Rita wants to put one cheese slice and one burger into each bread roll.
She wants to use all the cheese slices and all the burgers.

- (ii) How many bread rolls does Rita need?

..... bread rolls
(Total for Question is 4 marks)

5. Veena bought some food for a barbecue.
She is going to make some hot dogs.
She needs a bread roll and a sausage for each hot dog.
There are 40 bread rolls in a pack.
There are 24 sausages in a pack.
Veena bought exactly the same number of bread rolls and sausages.
(i) How many packs of bread rolls and packs of sausages did she buy?

..... packs of bread rolls

..... packs of sausages.

- (ii) How many hot dogs can she make?

.....
(Total for Question is 5 marks)

6. Find the highest common factor (HCF) of 32, 48 and 72

.....
(Total for question = 2 marks)

7. Write 504 as a product of powers of its prime factors.

.....
(Total for question = 3 marks)

8. John buys some boxes of pencils and some packets of pens for people to use at a conference.
There are 40 pencils in a box.
There are 15 pens in a packet.
John gives one pencil and one pen to each person at the conference.
He has no pencils left.
He has no pens left.
How many boxes of pencils and how many packets of pens did John buy?

..... boxes of pencils

..... packets of pens

(Total for question = 3 marks)

Laws of Indices

Things to remember:

- The exam question will use the word “simplify”
- When multiplying, add the indices
- When dividing, subtract the indices
- With brackets, multiply the indices
- If the exam question has the words “work out the value of”, or “evaluate” it means the answer is a number.
- Anything to the power zero is 1
- Anything to the power one is itself
- Anything to a negative power becomes a reciprocal

Questions:

1. (a) Write down the reciprocal of 5

.....
(1)

(b) Evaluate 3^{-2}

.....
(1)

(Total for Question is 2 marks)

2. (a) Write down the value of $\sqrt{81}$

.....
(1)

(b) Work out the value of $5^2 + 2^3$

.....
(2)

(Total for Question is 3 marks)

3. Write these numbers in order of size. Start with the smallest number.

5^{-1} 0.5 -5 5^0

.....
(Total for Question is 2 marks)

4. (a) Solve $3x^2 = 147$

.....
(2)

(b) Work out the value of 2^{-3}

.....
(1)

(c) Simplify $(3x^2)^3$

.....
(2)

(Total for question = 5 marks)

5. (a) Simplify $a^4 \times a^5$

.....
(1)

(b) Simplify $\frac{45e^6f^8}{5ef^2}$

.....
(2)

(c) Write down the value of $9^{\frac{1}{2}}$

.....
(1)
(Total for Question is 4 marks)

6. (a) Simplify $5^4 \times 5^6$

.....
(1)

(b) Simplify $7^5 \div 7^2$

.....
(1)
(Total for Question is 2 marks)

7. Write down the value of

(i) 7^0

(ii) 5^{-1}

(iii) $9^{\frac{1}{2}}$

.....
.....
.....
(Total for Question is 3 marks)

8. (a) Work out 3^4

.....
(1)

(b) Write down the cube root of 64

.....
(1)
(Total for Question is 2 marks)

Rounding

Things to remember:

- If the next number is less than 5, round down.
- If the next number is 5 or more, round up.

Questions:

1. Write the number 2.738 correct to 2 decimal places.

.....
(Total for Question is 1 mark)

2. Write the number **7378** to the nearest hundred.

.....
(Total for Question is 1 mark)

3. 28569 people watch a football match. Write 28569 to the nearest hundred.

.....
(Total for Question is 1 mark)

4. (a) Write 5643 to the nearest hundred.

.....
(1)

(b) Write 197 768 to the nearest thousand.

.....
(1)
(Total for Question is 2 marks)

5. (a) Write the number 28.75 to the nearest whole number.

.....
(1)

(b) Write the number 7380 to the nearest thousand.

.....
(1)
(Total for Question is 4 marks)

6. Write down 157 correct to the nearest 10

.....
(Total for Question is 1 mark)

7. Write 6431 to the nearest thousand.

.....
(Total for Question is 1 mark)

8. Write 6718 correct to the nearest hundred.

.....
(Total for Question is 1 mark)

BIDMAS

Things to remember:

- BIDMAS is the order in which operations need to be carried out.
- Brackets, indices, division, multiplication, addition, subtraction.

Questions:

1. Work out

(i) $2 \times 3 + 4$

(ii) $10 - 2 \times 5$

(iii) $16 \div (2 \times 4)$

.....
.....
.....
(Total 3 marks)

2. Beth says $20 - 5 \times 3$ is 45

Pat says $20 - 5 \times 3$ is 5

(a) Who is right?

Give a reason for your answer.

..... is right because

(b) Work out $(12 + 9) \div 3$

.....
.....
.....
(1)
(Total 2 marks)

3. Work out

(i) $3 \times 3 - 5$

(ii) $20 \div (12 - 2)$

(iii) $7 + 8 \div 4$

.....
.....
.....
(Total 3 marks)

4. (a) Work out $2 \times (11 + 9)$

.....
(1)

(b) Work out $3 \times 5 + 4$

.....
(1)

(c) Work out $20 - 5 \times 3$

.....
(1)
(Total 3 marks)

5. (a) Work out $4 \times 5 - 8$

.....
(1)

(b) Work out $18 + 2 \times 3$

.....
(1)

(c) Work out $(4 + 3) \times 7$

.....
(1)
(Total 3 marks)

6. (a) Work out the value of $(2 + 3) \times 4 + 5$

.....
(1)

(b) Add brackets () to make each statement correct.
You may use more than one pair of brackets in each statement.

(i) $2 + 3 \times 4 + 5 = 29$

(ii) $2 + 3 \times 4 + 5 = 45$

(2)
(Total 3 marks)

nth term

Things to remember:

- The gap between the numbers is the number that goes in front of n e.g. $4n$
- Then add on the zero term.
- If you're asked to write down terms of a sequence – use $n=1$, $n=2$, $n=3$ etc.

Questions:

1. Here are some patterns made from sticks.

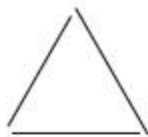

Pattern number 1



Pattern number 2

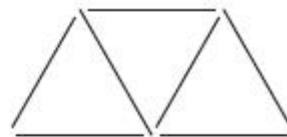

Pattern number 3

In the space below, draw Pattern number 4

(b) Complete the table.

Pattern number	1	2	3	4	5
Number of sticks	3	5	7		

(c) How many sticks make Pattern number 15?

.....
(1)
(Total for Question is 3 marks)

2. Here are the first four terms of a number sequence.

6 10 14 18

(2) Write down the next term in this sequence.

.....
(1)

(b) Find the 10th term in this sequence.

.....
(1)

(c) The number 102 is **not** a term in this sequence. Explain why.

.....
.....
(1)
(Total for Question is 3 marks)

3. Here are the first four terms of a number sequence.

3 7 11 15

(2) Write down the next term of this sequence.

.....
(1)

The 50th term of this number sequence is 199

(b) Write down the 51st term of this sequence.

.....
(1)

The number 372 is **not** a term of this sequence.

(c) Explain why.

.....
.....
(1)

(Total for Question is 3 marks)

4. Here are the first 5 terms of an arithmetic sequence.

6, 11, 16, 21, 26

Find an expression, in terms of n , for the n th term of the sequence.

.....
(Total 2 marks)

5. Here are the first five terms of a number sequence.

3 7 11 15 19

(a) Work out the 8th term of the number sequence.

.....
(1)

(b) Write down an expression, in terms of n , for the n th term of the number sequence.

.....
(2)
(Total 3 marks)

6. The first five terms of an arithmetic sequence are

2 9 16 23 30

Find, in terms of n , an expression for the n th term of this sequence.

.....
(Total 2 marks)

7. Here are the first four terms of a number sequence.

2 7 12 17

(a) Write down the **6th** term of this number sequence.

.....
(1)

The n th term of a different number sequence is $4n + 5$

(b) Work out the first three terms of this number sequence.

.....
(2)
(Total 3 marks)

8. The n th term of a number sequence is given by $3n + 1$

(a) Work out the first **two** terms of the number sequence.

.....
(1)

Here are the first four terms of another number sequence.

1 5 9 13

(b) Find, in terms of n , an expression for the n th term of this number sequence.

.....
(2)
(Total 3 marks)

Sketching Linear Graphs

Things to remember:

- Draw a table of values with x and y .
- Work out the value of y when $x = 0$, $x = 1$, $x = 2$, then use the pattern to work out the rest.
- Don't forget to connect the coordinates with a straight line.

Question:

1. (a) Complete the table of values for $y = 3x + 4$

x	-2	-1	0	1	2	3
y		1				13

(b) On the grid, draw the graph of $y = 3x + 4$

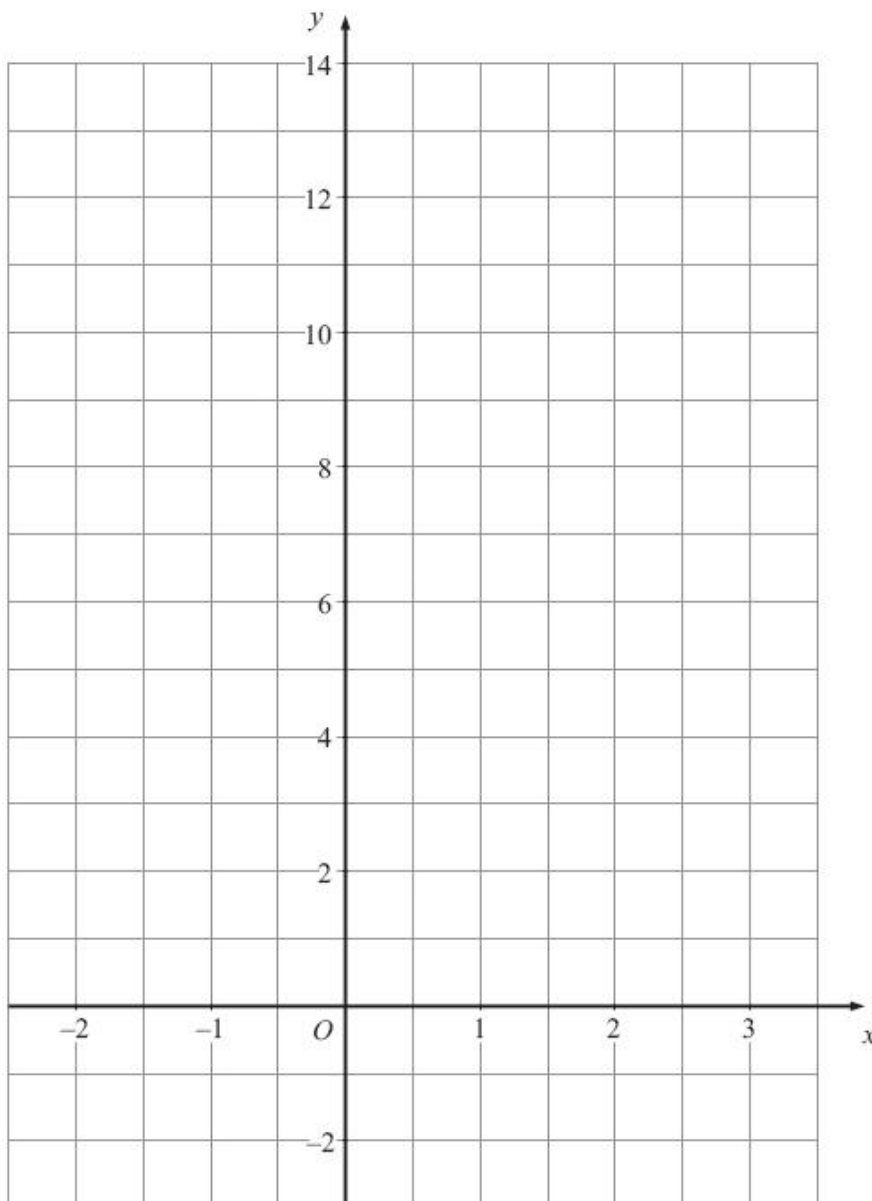

(2)
(Total for Question is 4 marks)

2. (a) Complete the table of values for $y = 2x + 2$

x	-2	-1	0	1	2	3	4
y	-2				6		

- (b) On the grid, draw the graph of $y = 2x + 2$

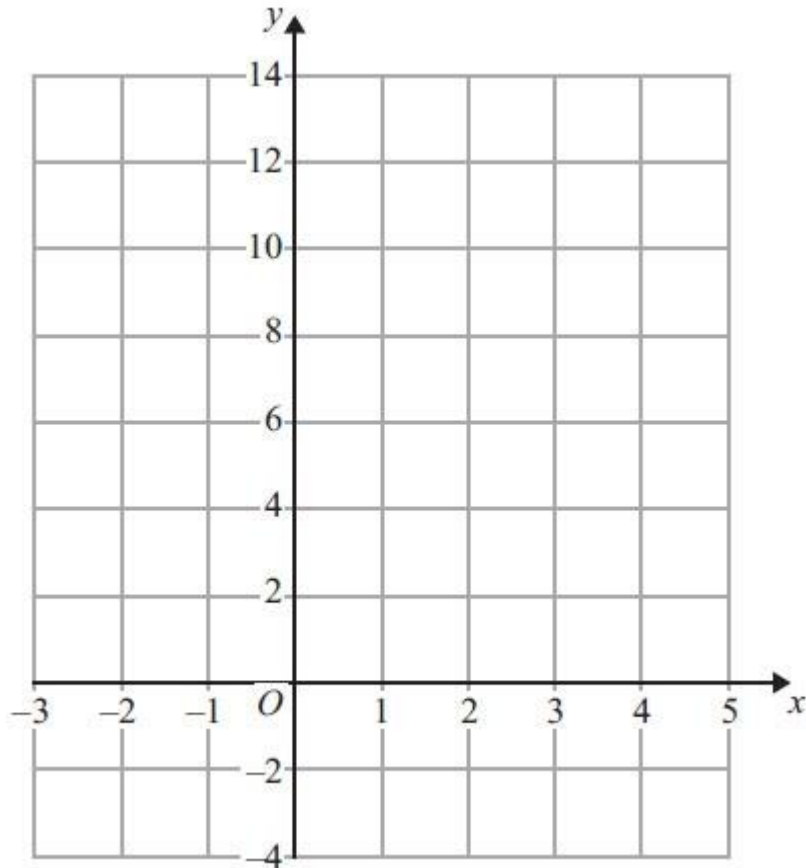

(2)
(Total for Question is 4 marks)

3. On the grid, draw the graph of $y = 4x + 2$ from $x = -1$ to $x = 3$

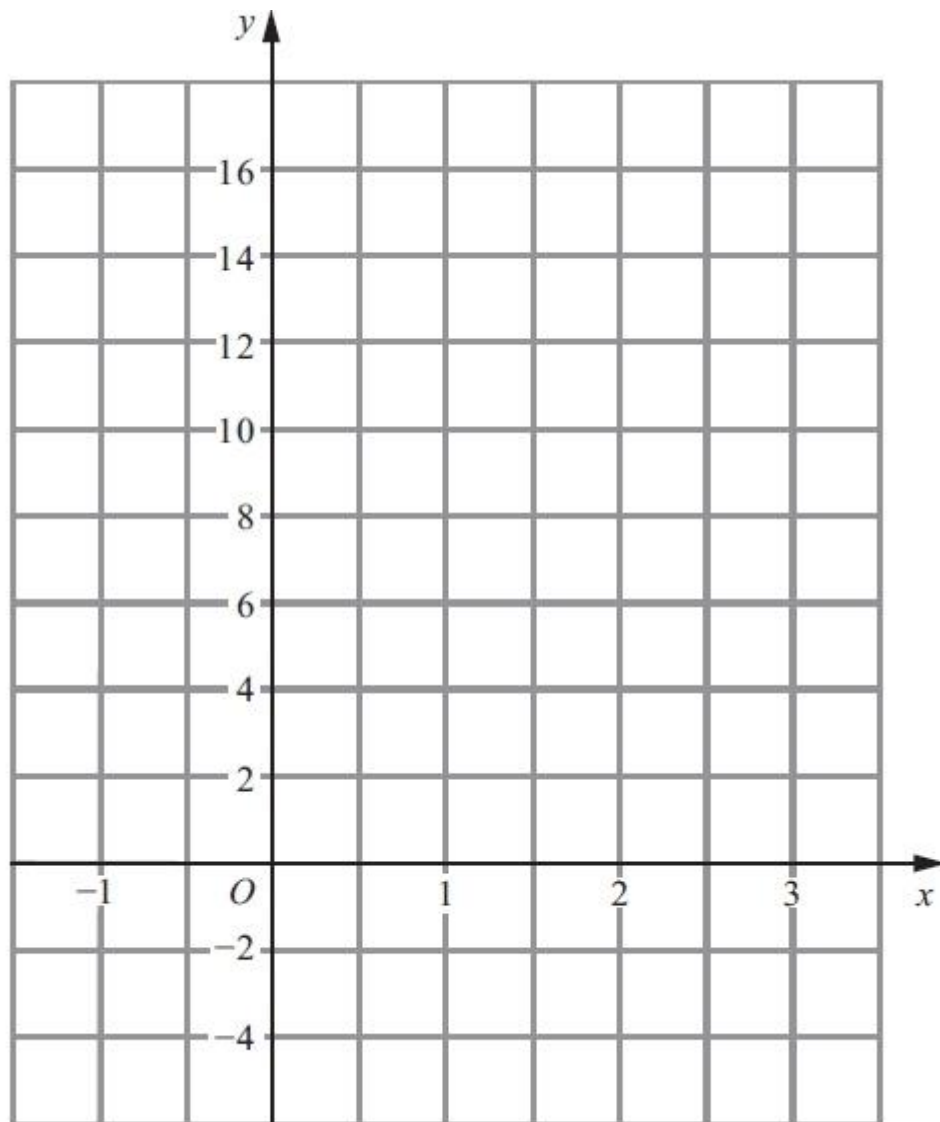

(Total for Question is 3 marks)

4. On the grid, draw the graph of $y = 2x - 3$ for values of x from -2 to 2

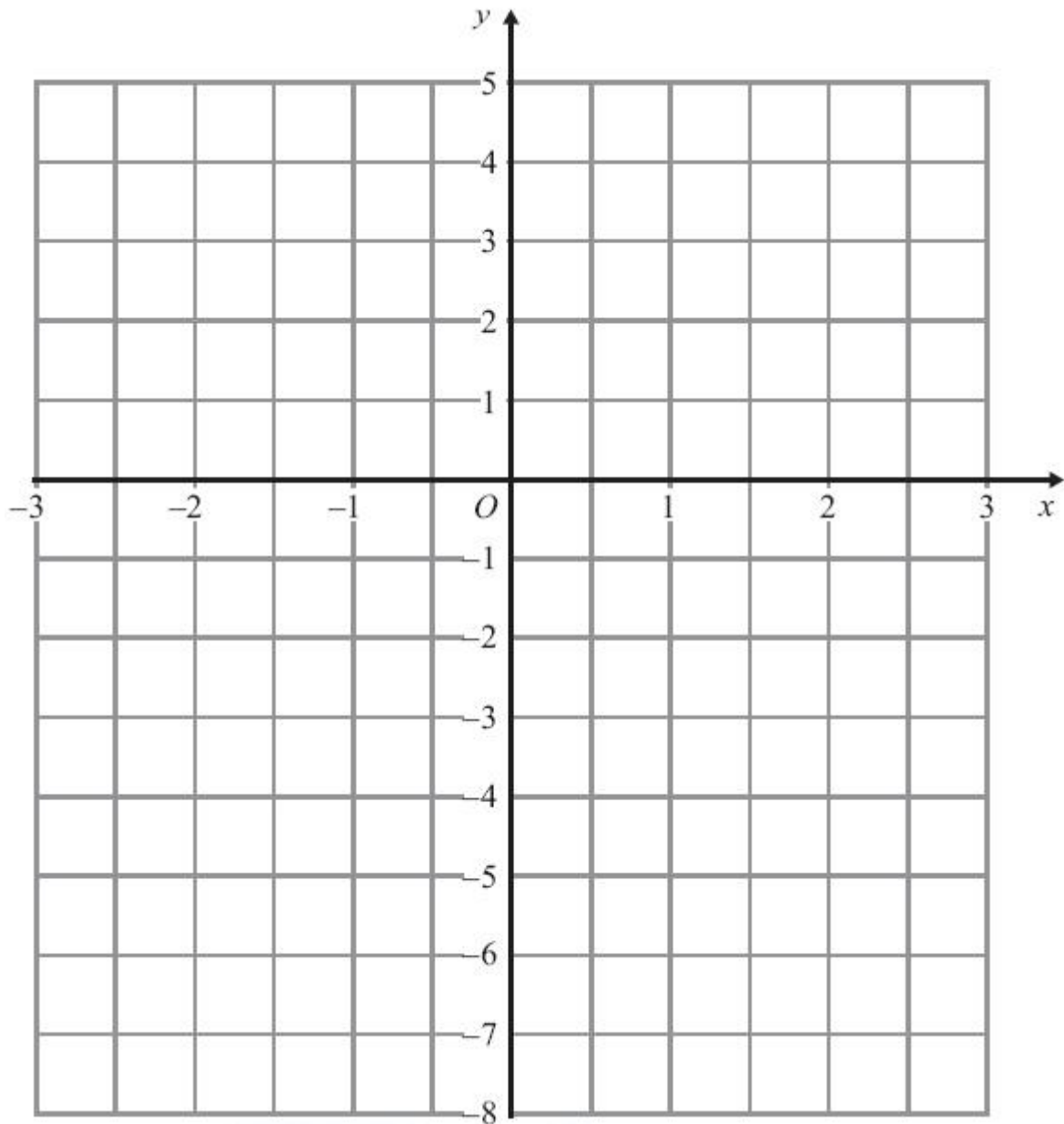

(Total for Question is 3 marks)

5. On the grid, draw the graph of $y = 2x + 3$ for values of x from $x = -3$ to $x = 1$

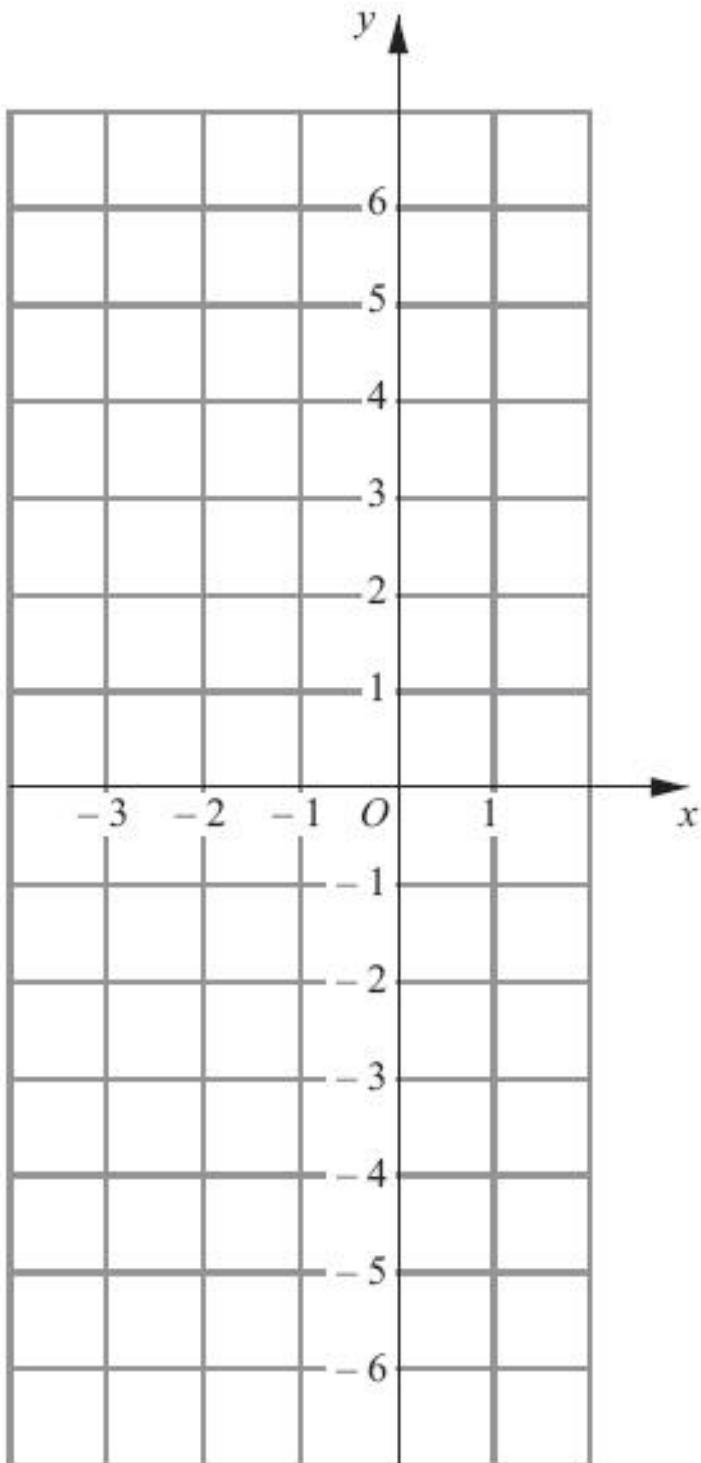

(Total for Question is 3 marks)

6. On the grid, draw the graph of $y = 2x - 1$ for values of x from -2 to 3

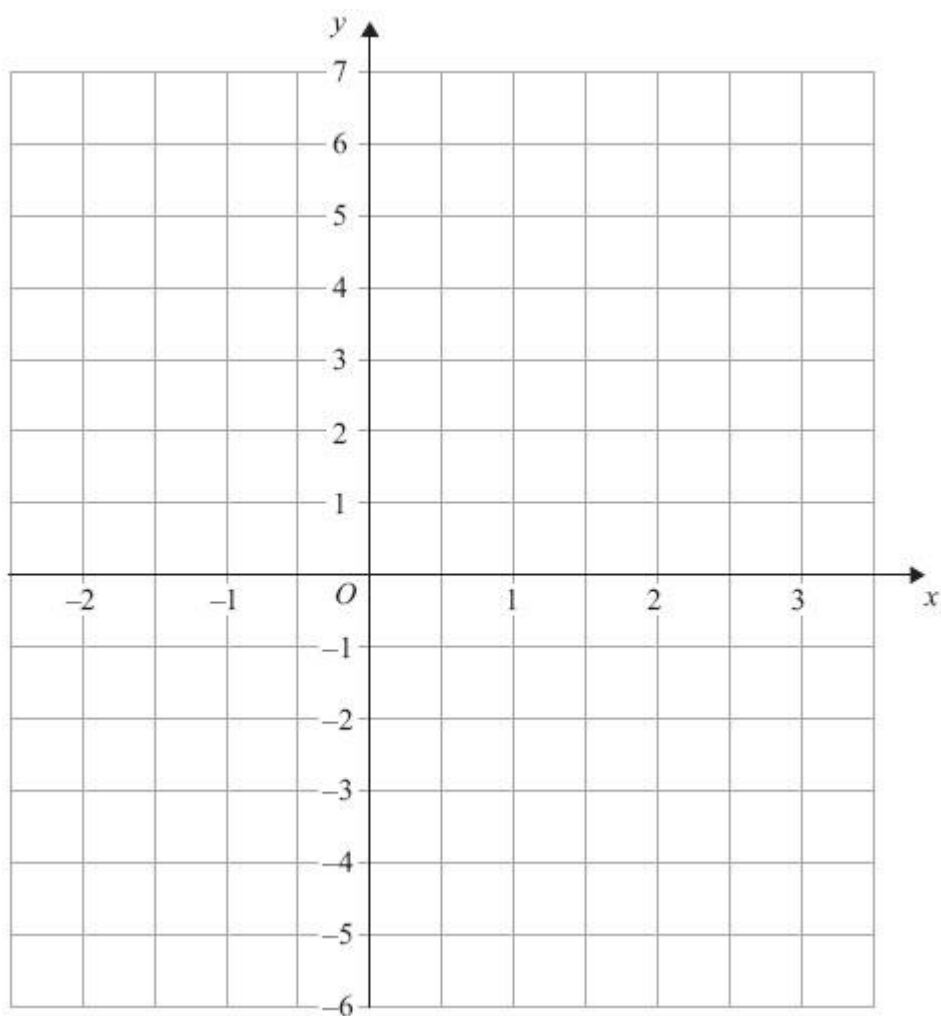

(Total for Question is 3 marks)

7. On the grid, draw the graph of $y = \frac{1}{2}x + 3$ for values of x from -2 to 4

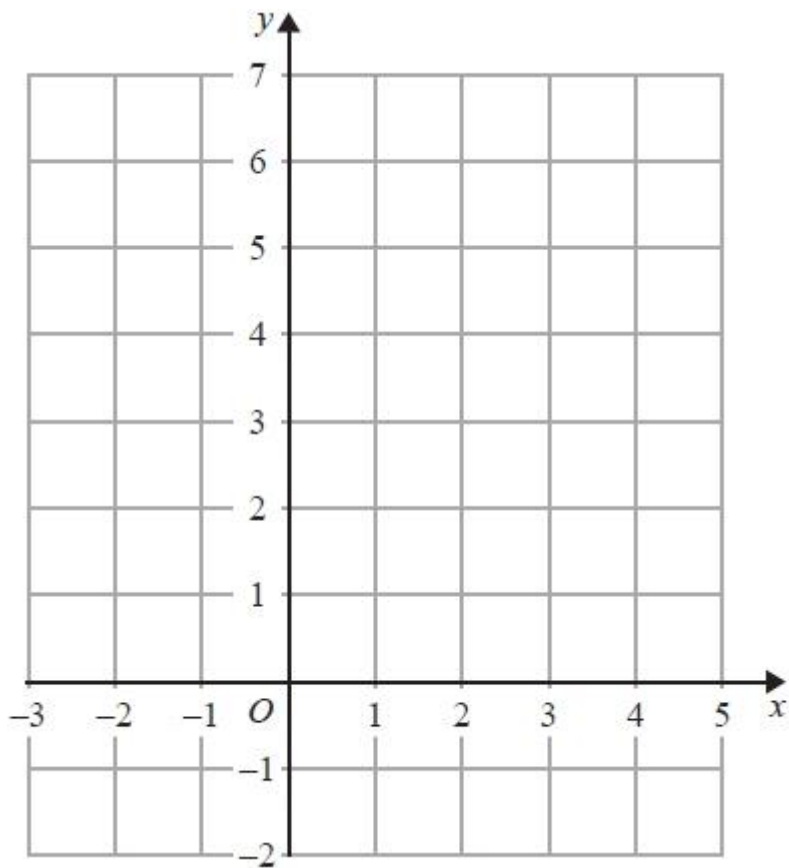

(Total for question = 3 marks)

8. On the grid, draw the graph of $y = \frac{1}{2}x + 5$ for values of x from -2 to 4

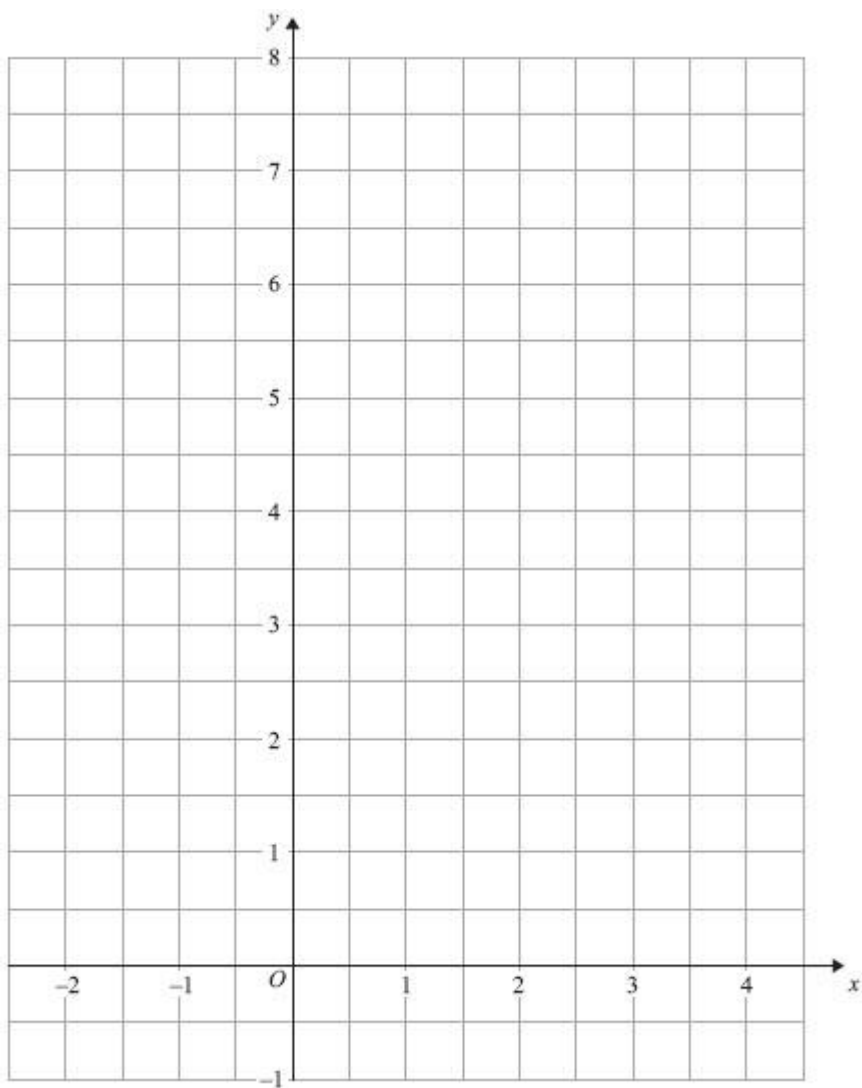

(Total for Question is 3 marks)

Expanding and Factorising (Single Brackets)

Things to remember:

- Expand brackets means to multiply what is outside the bracket with everything inside the bracket.
- Factorising is the opposite of expanding – put the HCF outside the brackets to factorise fully.

Questions:

1. (a) Expand $5(m + 2)$

.....
(1)

(b) Factorise $y^2 + 3y$

.....
(1)

(c) Simplify $a^5 \times a^4$

.....
(1)

(Total for Question is 3 marks)

2. (a) Expand $2m(m + 3)$

.....
(1)

(b) Factorise fully $3xy^2 - 6xy$

.....
(2)

(Total for Question is 3 marks)

3. (a) Expand $3(x + 4)$

.....
(1)

(b) Expand $x(x^2 + 2)$

.....
(2)

(c) Factorise $x^2 - 6x$

.....
(1)

(Total for Question is 4 marks)

4. (a) Expand and simplify $5(x + 7) + 3(x - 2)$

.....
(2)

(b) Factorise completely $3a^2b + 6ab^2$

.....
(2)
(Total for Question is 4 marks)

5. (a) Expand $3(2y - 5)$

.....
(1)

(b) Factorise completely $8x^2 + 4xy$

.....
(2)
(Total for Question is 3 marks)

6. (a) Factorise $3x + 6$

.....
(1)

(b) Expand and simplify $5(y - 2) + 2(y - 3)$

.....
(2)
(Total for Question is 3 marks)

7. (a) Factorise $4x + 10y$

.....
(1)

(b) Factorise $x^2 + 7x$

.....
(1)
(Total for Question is 2 marks)

Solving Equations

Things to remember:

- “Solve” means to find the value of the variable (what number the letter represents).
- The inverse of + is – and the inverse of \times is \div
- Work one step at a time, keeping you = signs in line on each new row of working.

Questions:

1. Solve $4x + 3 = 19$

$x = \dots\dots\dots$
(Total 2 marks)

2. (a) Solve $6x - 7 = 38$

$x = \dots\dots\dots$
(2)

(b) Solve $4(5y - 2) = 40$

$y = \dots\dots\dots$
(3)
(Total 5 marks)

3. Solve $5(2y + 3) = 20$

$y = \dots\dots\dots$
(Total 3 marks)

4. (a) Solve $7x + 18 = 74$

$x = \dots\dots\dots$
(2)

(b) Solve $4(2y - 5) = 32$

$y = \dots\dots\dots$
(2)

(c) Solve $5p + 7 = 3(4 - p)$

$p = \dots\dots\dots$
(3)
(Total 7 marks)

5. (a) Solve $7p + 2 = 5p + 8$

$p = \dots\dots\dots$
(2)

(b) Solve $7r + 2 = 5(r - 4)$

$r = \dots\dots\dots$
(2)
(Total 4 marks)

6. Solve
 $4y + 1 = 2y + 8$

$y = \dots\dots\dots$
(Total 2 marks)

7. Solve $4y + 3 = 2y + 8$

$y = \dots\dots\dots$
(Total 2 marks)

Inequalities

Things to remember:

- $<$ means less than
- $>$ means greater than
- \leq means less than or equal to
- \geq means greater than or equal to
- An integer is a whole number
- On a number line, use a full circle to show a value can be equal, and an empty circle to show it cannot.

Questions:

1. (i) Solve the inequality
 $5x - 7 < 2x - 1$

- (ii) On the number line, represent the solution set to part (i).

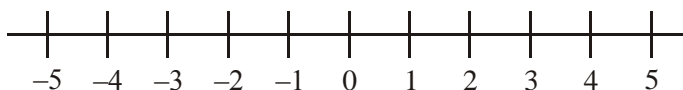

(Total 3 marks)

2. (a) List all the possible integer values of n such that
 $-2 \leq n < 3$

.....
(2)

- (b) Solve the inequality
 $4p - 8 < 7 - p$

(2)
(Total 4 marks)

3. (a) $-3 \leq n < 2$
 n is an integer.
Write down all the possible values of n .

.....
(2)

- (b) Solve the inequality
 $5x < 2x - 6$

.....
(2)
(Total 4 marks)

4. (a) Solve the inequality
 $3t + 1 < t + 12$

.....
(2)

- (b) t is a whole number.
Write down the largest value of t that satisfies
 $3t + 1 < t + 12$

.....
(1)
(Total 3 marks)

5. Solve $4 < x - 2 \leq 7$

.....
(Total 3 marks)

6. Solve $5x + 3 > 19$

.....
(Total 2 marks)

Substitution

Things to remember:

- There is always 1 mark just for writing down the numbers you have had to put into the expression.
- Your answer must be a number – don't forget to finish the sum
- The question will always use the words "Work out the value of"

Questions:

1. (a) Work out the value of $3x - 4y$ when $x = 3$ and $y = 2$

.....
(2)

(b) Work out the value of $\frac{p(q-3)}{4}$ when $p = 2$ and $q = -7$

.....
(3)
(Total 5 marks)

2. Find the value of $t^2 - 4t$ when $t = -3$

.....
(Total 2 marks)

3. $P = x^2 - 7x$
Work out the value of P when $x = -5$

$P =$
(Total 2 marks)

4. T, x and y are connected by the formula
 $T = 5x + 2y$
 $x = -3$ and $y = 4$
 (a) Work out the value of T.

T =
 (2)

- T = 16 and x = 7
 (b) Work out the value of y.

y =
 (3)
 (Total 5 marks)

5. $P = 4k - 10$
 $P = 50$
 (a) Work out the value of k.

.....
 (2)

- $y = 4n - 3d$
 $n = 2$
 $d = 5$
 (b) Work out the value of y.

.....
 (2)
 (Total 4 marks)

6. $h = 5t^2 + 2$

(i) Work out the value of h when $t = -2$

(ii) Work out a value of t when $h = 47$

.....

.....

(Total 3 marks)

Angle Rules

Things to remember:

- Angles in a triangle sum to 180°
- Angles on a straight line sum to 180°
- Angles around a point sum to 360°
- Vertically opposite angles are equal
- Alternate angles are equal
- Corresponding angles are equal
- Supplementary angles sum to 180°

Questions:

*1. ABC is parallel to $EFGH$.

$$GB = GF$$

$$\text{Angle } ABF = 65^\circ$$

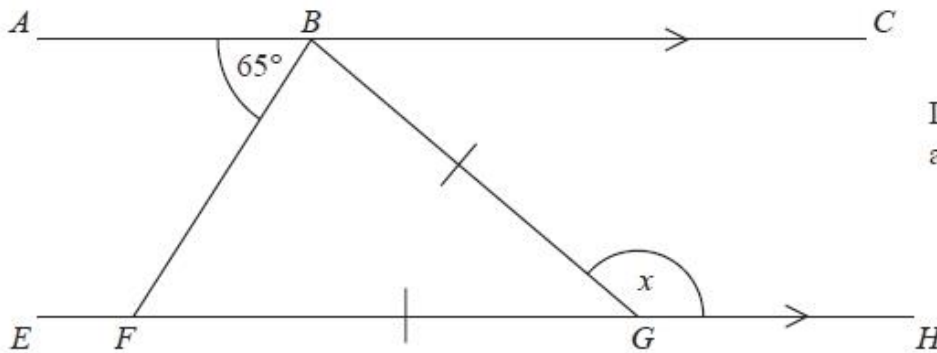

Diagram NOT
accurately drawn

Work out the size of the angle marked x .
Give reasons for your answer.

(Total for Question is 4 marks)

- *2. $ABCD$ and EFG are parallel lines.
 $BC = CF$
 Angle $BFE = 70^\circ$

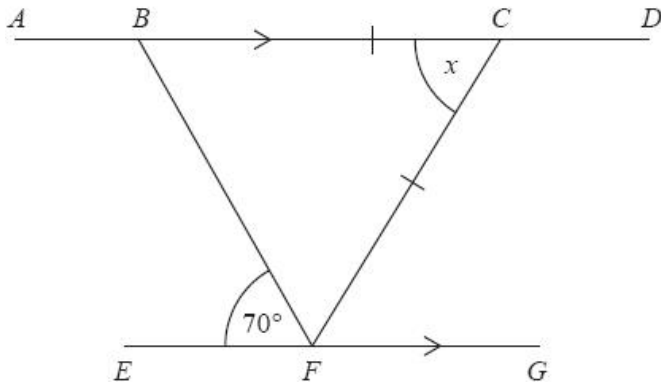
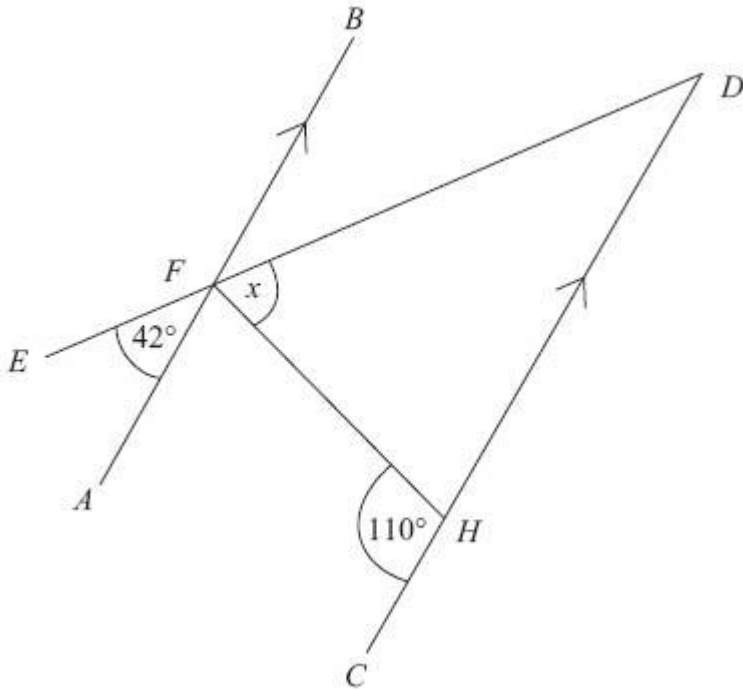

Diagram NOT
 accurately drawn

Work out the size of the angle marked x .
 Give reasons for each stage of your working.

(Total for question = 4 marks)

3. AFB and CHD are parallel lines.
 EFD is a straight line.



Work out the size of the angle marked x .

Diagram NOT accurately drawn

$x = \dots\dots\dots$
(Total for Question is 3 marks)

- *4. ABC is a straight line.
 $DEFG$ is a straight line.
 AC is parallel to DG .
 $EF = BF$.
Angle $BEF = 50^\circ$.

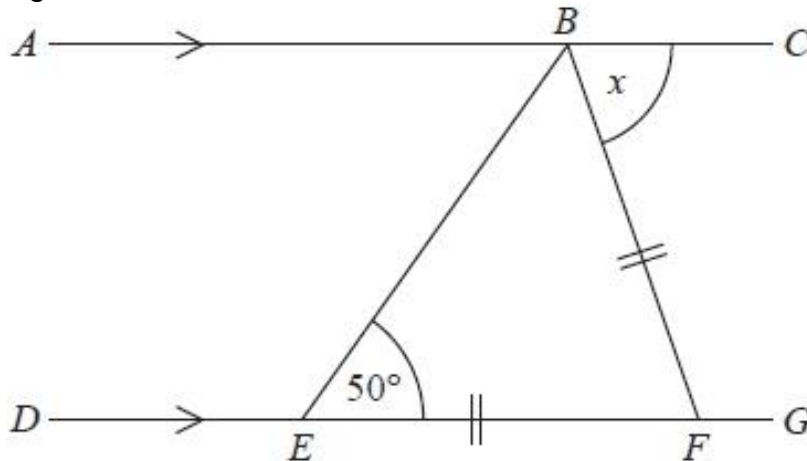

Diagram **NOT**
accurately drawn

Work out the size of the angle marked x .
Give reasons for your answer.

.....^o
(Total for Question is 4 marks)

5.

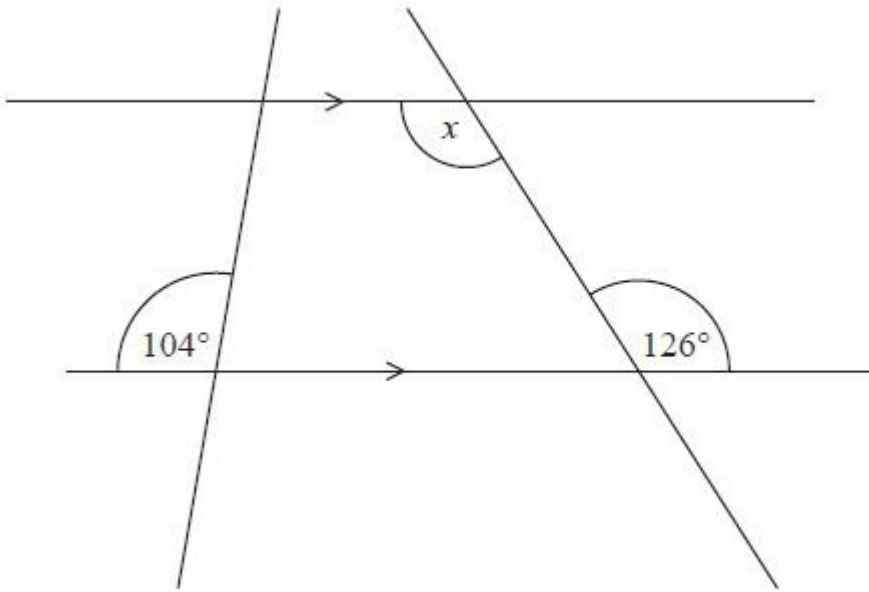

Diagram **NOT**
accurately drawn

(i) Find the size of the angle marked x .

..... °

(ii) Give a reason for your answer.

.....

.....

(Total for Question is 2 marks)

6. ABC and DEF are parallel lines.
 BEG is a straight line.
Angle $GEF = 47^\circ$.

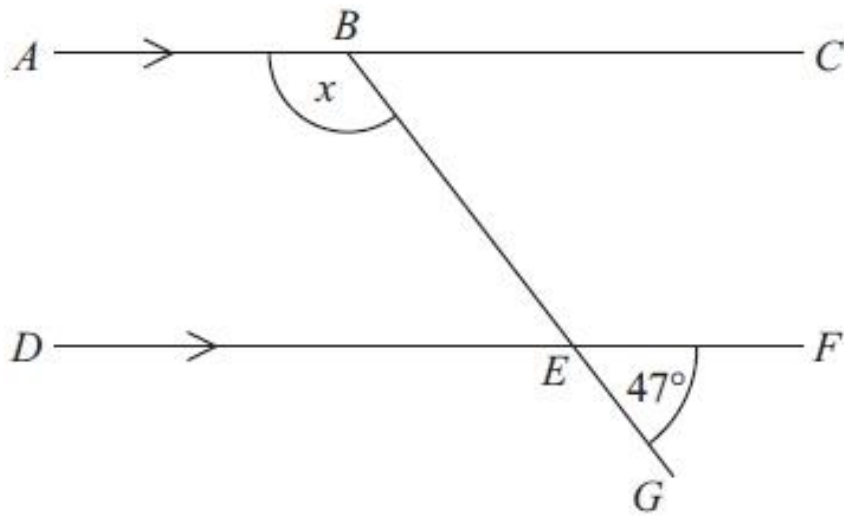

Diagram NOT accurately drawn
Work out the size of the angle marked x .
Give reasons for your answer.

.....^o
(Total for Question is 3 marks)

Constructing Triangles

Things to remember:

- If you are given angles, you can use a protractor.
- If you are not given angles, you will need to use compasses.

Questions:

1. In the space below, use ruler and compasses to **construct** an equilateral triangle with sides of length 8 cm.
You must show all your construction lines.
One side of the triangle has already been drawn for you.

(Total for Question is 2 marks)

2. In the space below, use a ruler and compasses to construct an equilateral triangle with sides of length 5 cm.
You must show all your construction lines.
One side of the triangle has been drawn for you.

(Total for question = 2 marks)

3. Here is a triangle.

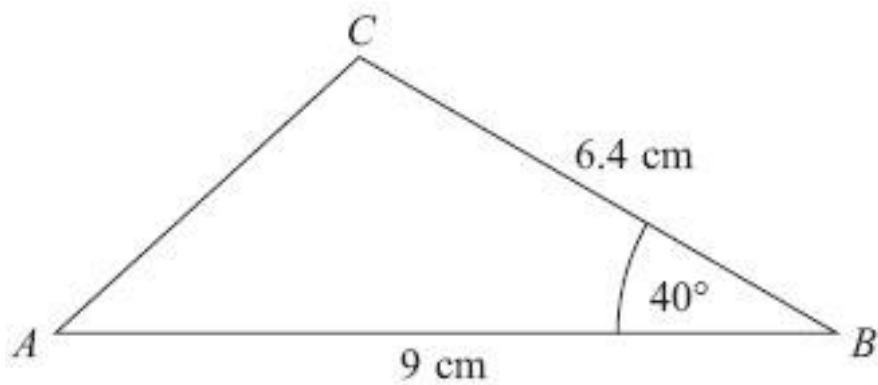

Diagram **NOT**
accurately drawn

Make an accurate drawing of triangle ABC .
The line AB has already been drawn for you.



(Total for Question is 2 marks)

Bearings

Things to remember:

- Always measure bearing clockwise from the North line and give your answer 3 digits.
- If the diagram is drawn accurately, use the given scale.
- If the diagram is not drawn accurately, use the fact that the North lines are all parallel.

Questions:

1. Martin and Janet are in an orienteering race.
Martin runs from checkpoint *A* to checkpoint *B*, on a bearing of 065°
Janet is going to run from checkpoint *B* to checkpoint *A*.
Work out the bearing of *A* from *B*.

..... °
(Total for question = 2 marks)

2. The bearing of a ship from a lighthouse is 050°
Work out the bearing of the lighthouse from the ship.

..... °
(Total for Question is 2 marks)

3. The map shows the positions of three places *A*, *B* and *C* on the edge of a lake.

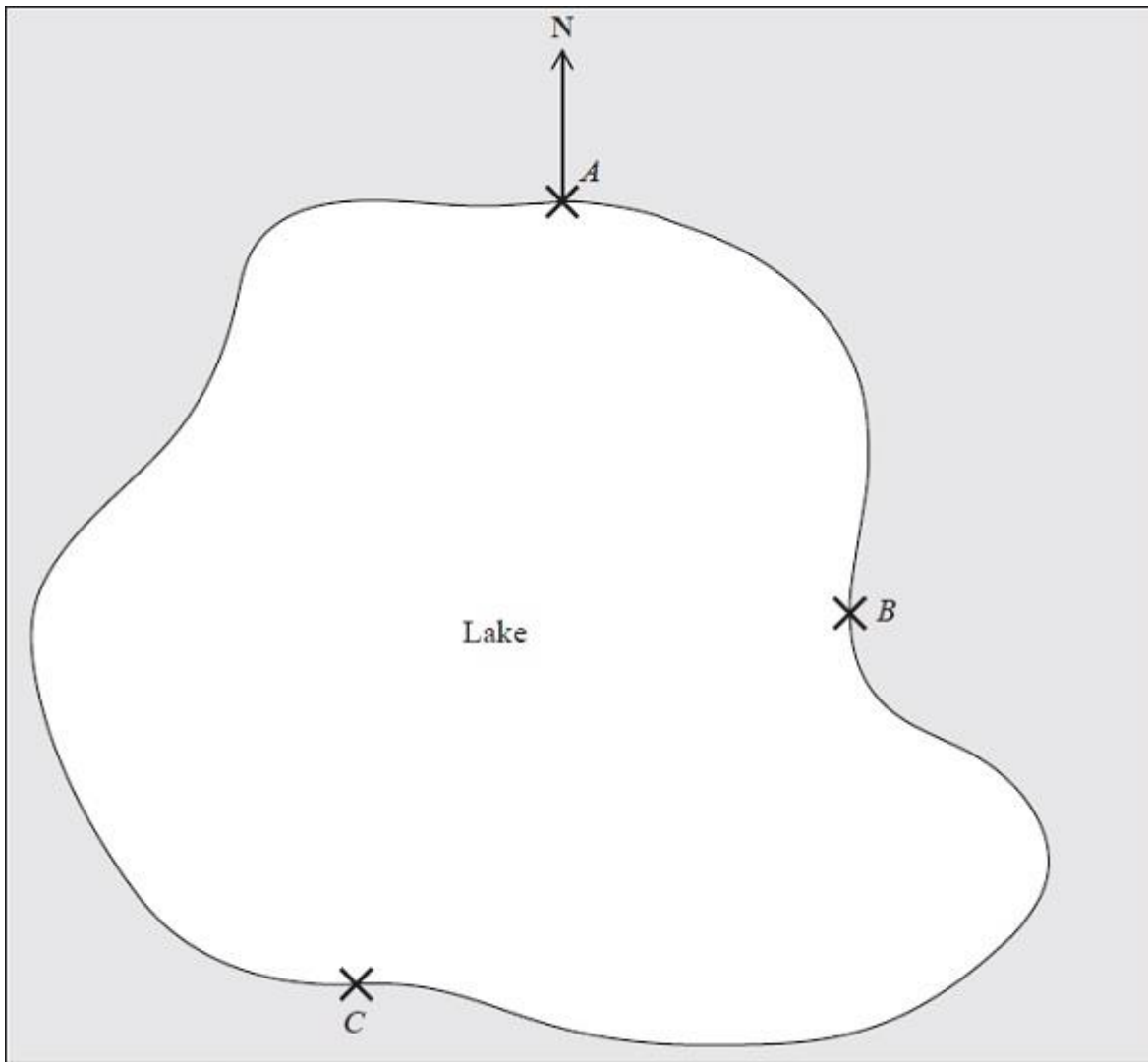

Scale 1 cm represents 2 km

- (a) Find the bearing of *B* from *A*.

.....°
(1)

A ferry travels in a straight line from *A* to *B*.
It then travels in a straight line from *B* to *C*.
A speedboat travels in a straight line from *A* to *C*.

- (b) How many more kilometres does the ferry travel than the speedboat?
You must show your working.

..... km
(4)
(Total for Question is 5 marks)

4. The diagram shows part of a map.

- (a) Find the bearing of the church from the tower.



..... °
(1)

The scale of the map is 1 cm represents 2.5 km.

- (b) Work out the real distance between the tower and the church.



..... km
(2)

A school is 15 km due North of the church.

- (c) On the diagram, mark with a cross (x) the position of the school. Label your cross S.
(2)
(Total for Question is 5 marks)

5. The diagram shows the positions of a lighthouse and a harbour on a map.



A boat is on a bearing of 300° from the lighthouse
040° from the harbour.

On the diagram, mark with a cross (x) the position of the boat.
Label the boat B.

(Total for question = 3 marks)

6. The scale diagram shows the positions of two towns, *A* and *B*.

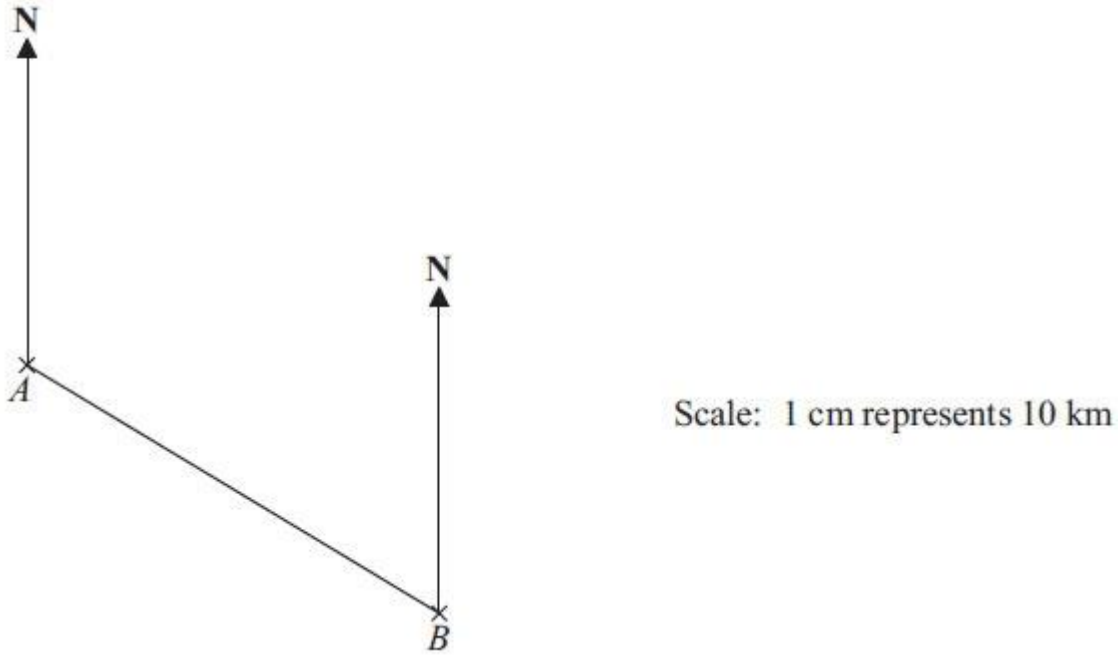

(a) Measure and write down the bearing of town *B* from town *A*.
 °
(1)

(b) What is the real distance from town *A* to town *B*?
 Give your answer in km.
 km
(3)

(Total for Question is 4 marks)

7. The diagram shows the positions of two villages, Beckhampton (*B*) and West Kennett (*W*).

Scale: 4 cm represents 1 km.

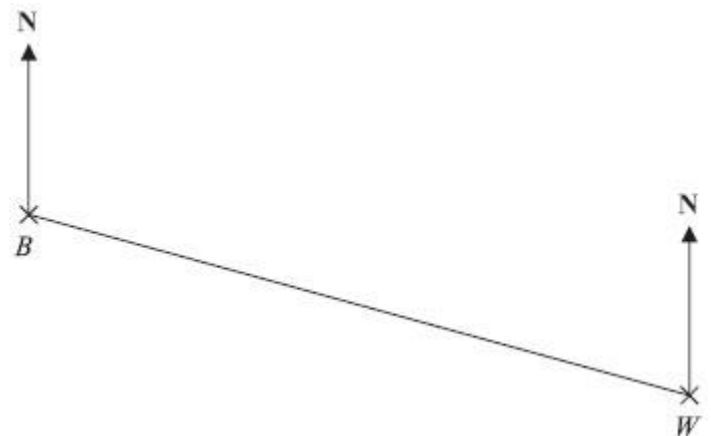

(a) Work out the real distance, in km, of Beckhampton from West Kennett.

..... km
(2)

The village, Avebury (*A*), is on a bearing of 038° from Beckhampton.

On the diagram, *A* is 6 cm from *B*.

(b) On the diagram, mark *A* with a cross (x).
 Label the cross *A*.

(2)

(Total for Question is 4 marks)

Transformations

Things to remember:

- Reflection – the shape is flipped in a mirror line
- Rotation – the shape is turned a number of degrees, around a centre, clockwise or anticlockwise
- Translation – the shape is moved by a vector $\begin{pmatrix} x \\ y \end{pmatrix}$
- Enlargement – the shape is made bigger or smaller by a scale factor from a centre.

Questions:

1.

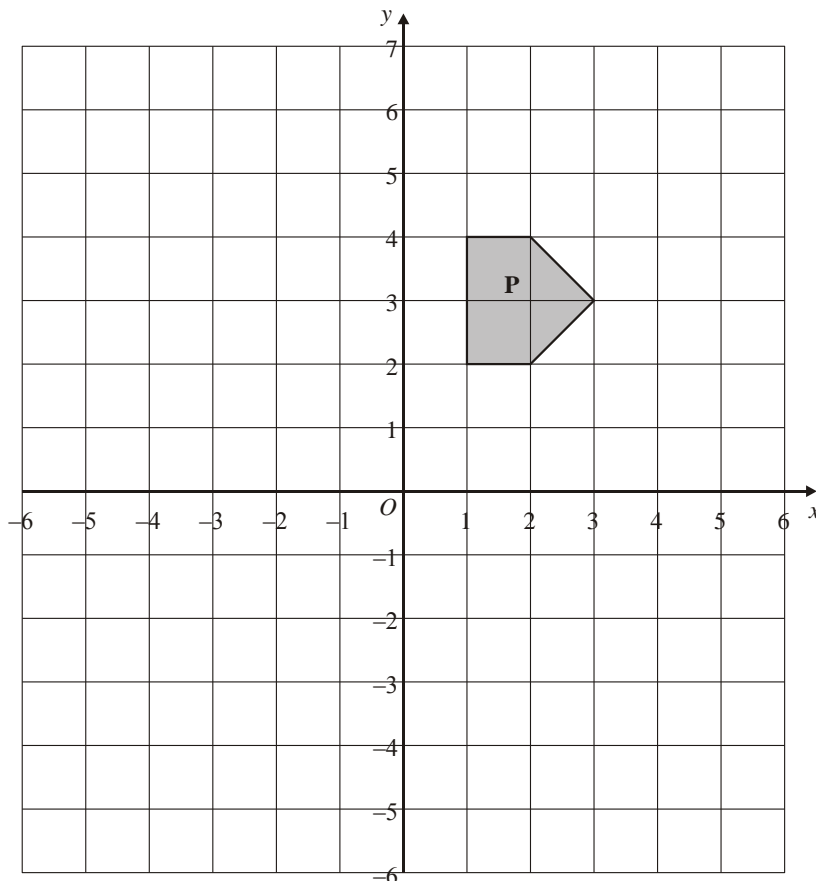

(a) On the grid, rotate the shaded shape **P** one quarter turn anticlockwise about **O**. Label the new shape **Q**.

(3)

(b) On the grid, translate the shaded shape **P** by 2 units to the right and 3 units up. Label the new shape **R**.

(1)

(Total 4 marks)

2.

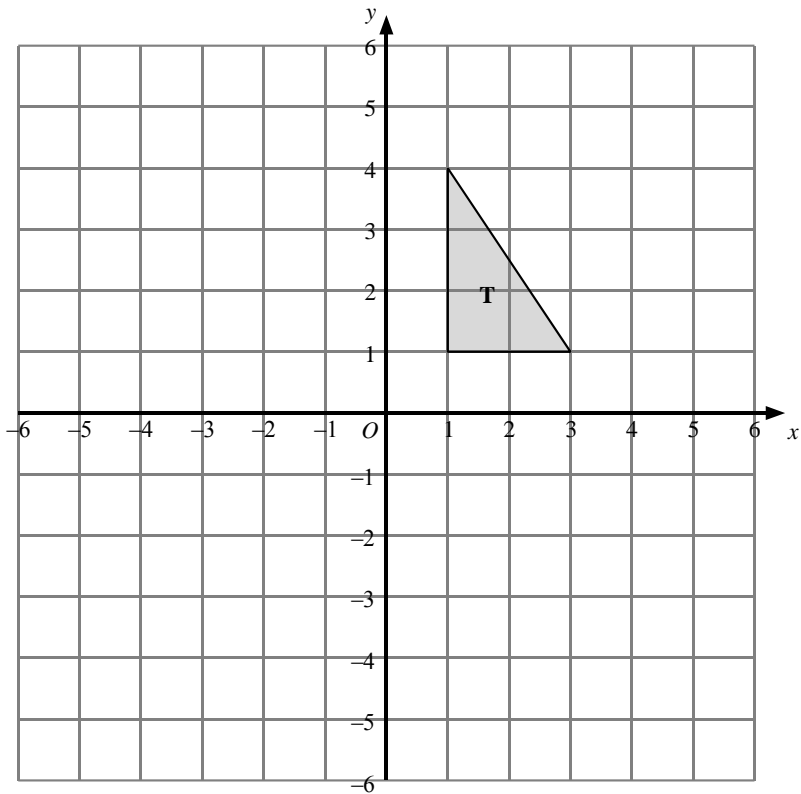

Triangle **T** has been drawn on the grid.

- (a) Reflect triangle **T** in the y -axis.
Label the new triangle **A**.
- (b) Rotate triangle **T** by a half turn, centre O .
Label the new triangle **B**.

(1)

(2)

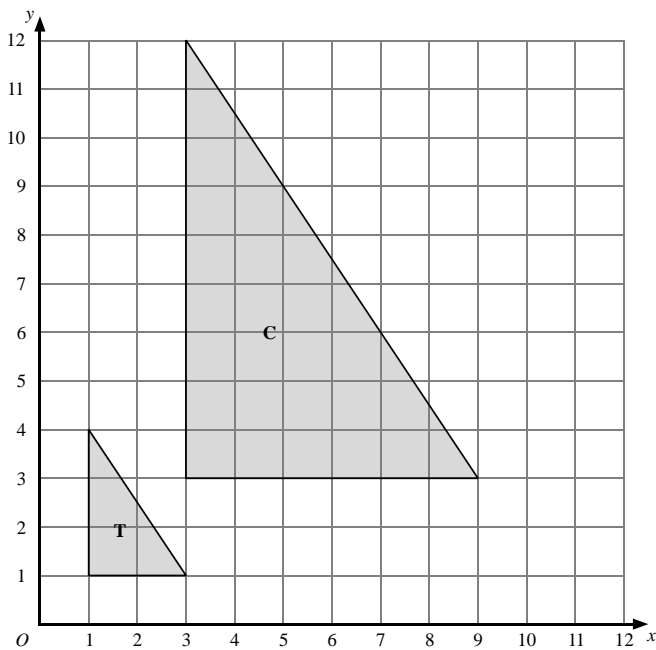

- (c) Describe fully the single transformation which maps triangle **T** onto triangle **C**.

.....

(3)

(Total 6 marks)

3.

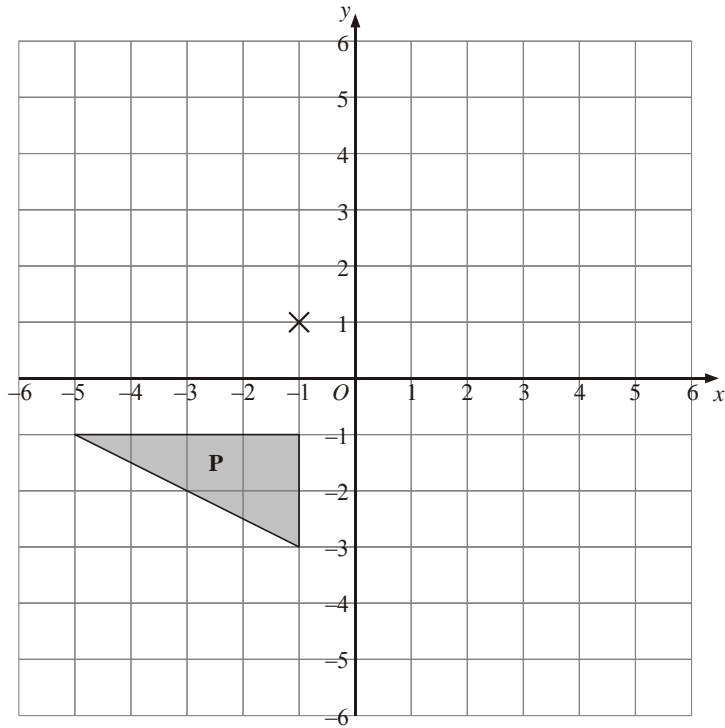

(a) Rotate triangle **P** 180° about the point $(-1, 1)$.
Label the new triangle **A**.

(2)

(b) Translate triangle **P** by the vector $\begin{pmatrix} 6 \\ -1 \end{pmatrix}$.
Label the new triangle **B**.

(1)

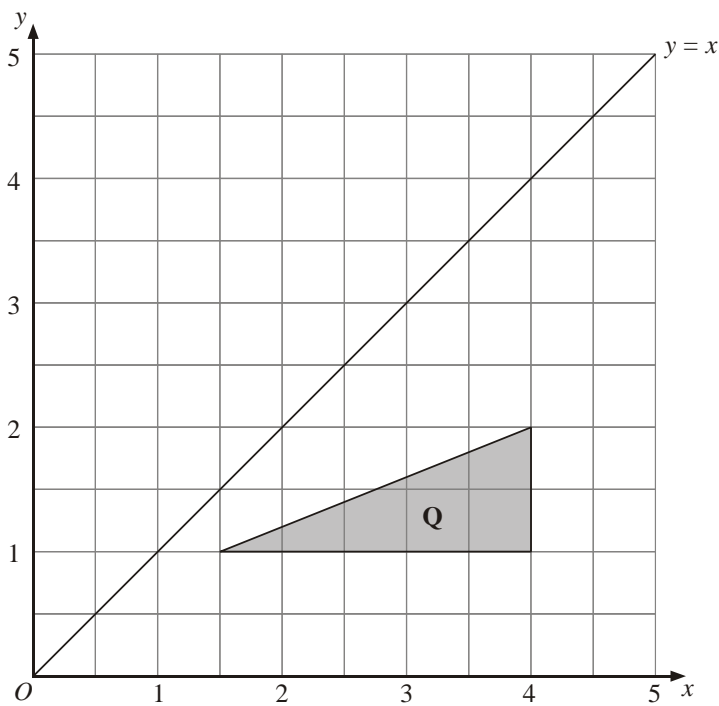

(c) Reflect triangle **Q** in the line $y = x$.
Label the new triangle **C**.

(2)

(Total 5 marks)

4.

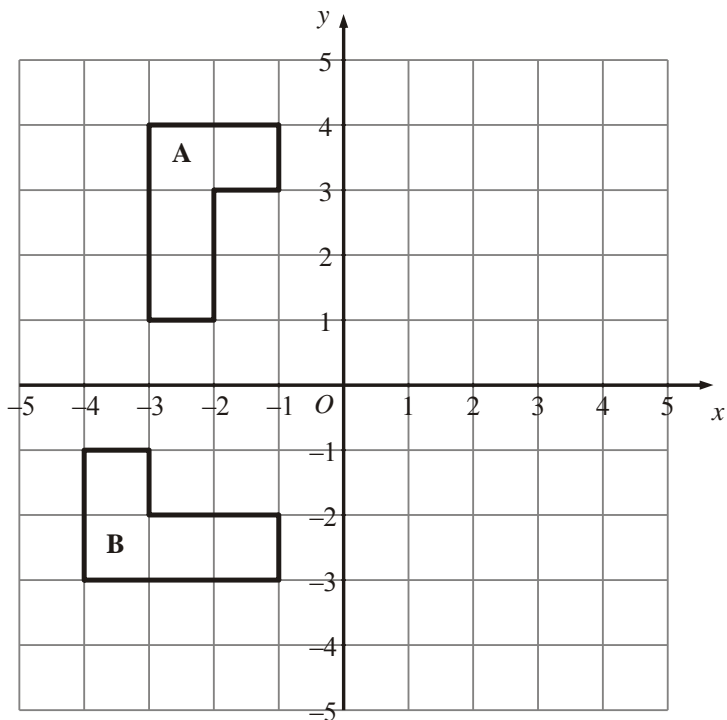

(a) Reflect shape **A** in the y axis.

(2)

(b) Describe fully the **single** transformation which takes shape **A** to shape **B**.

.....

(3)

(Total 5 marks)

5.

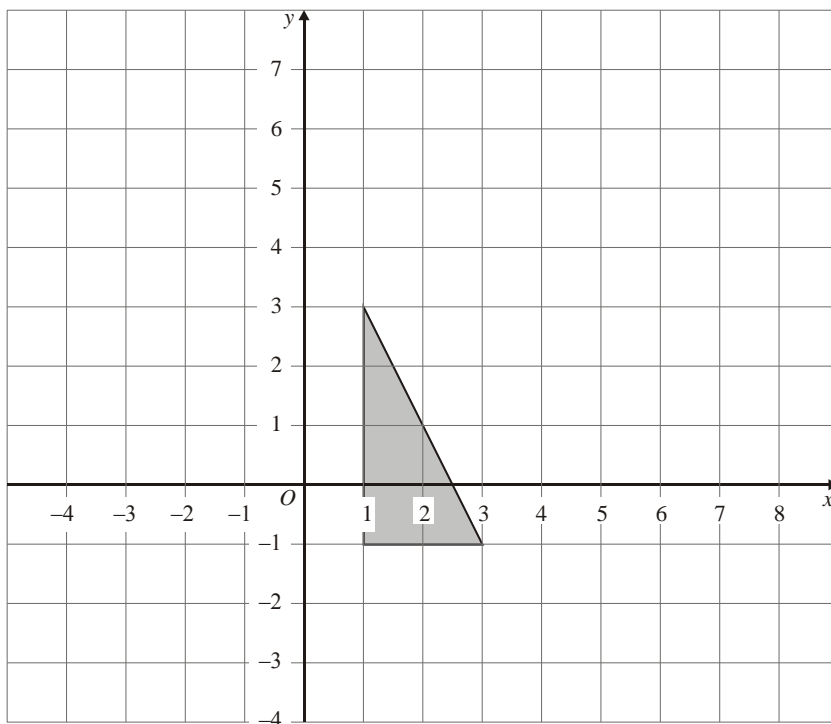

Enlarge the shaded triangle by a scale factor 2, centre 0.

(Total 3 marks)

6.

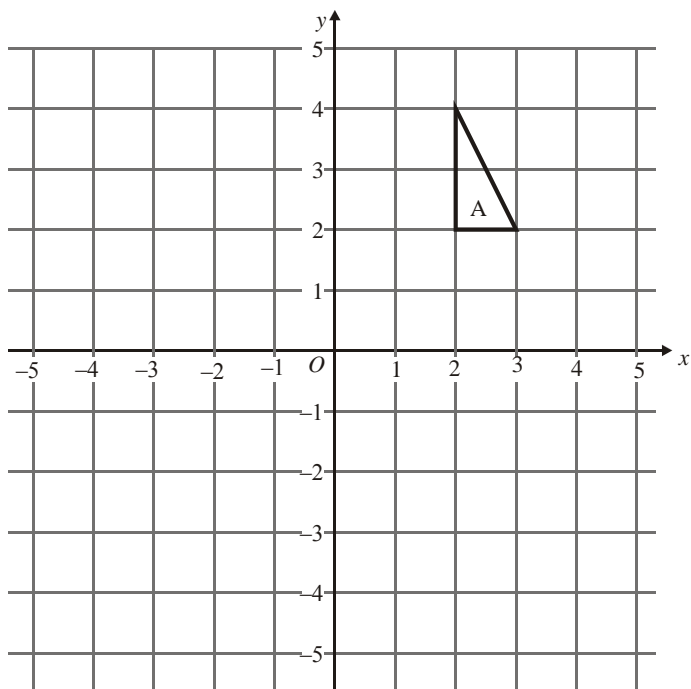

(a) On the grid, rotate triangle **A** 180° about **O**.
Label your new triangle **B**.

(2)

(b) On the grid, enlarge triangle **A** by scale factor $\frac{1}{2}$, centre **O**.
Label your new triangle **C**.

(3)

(Total 5 marks)

7.

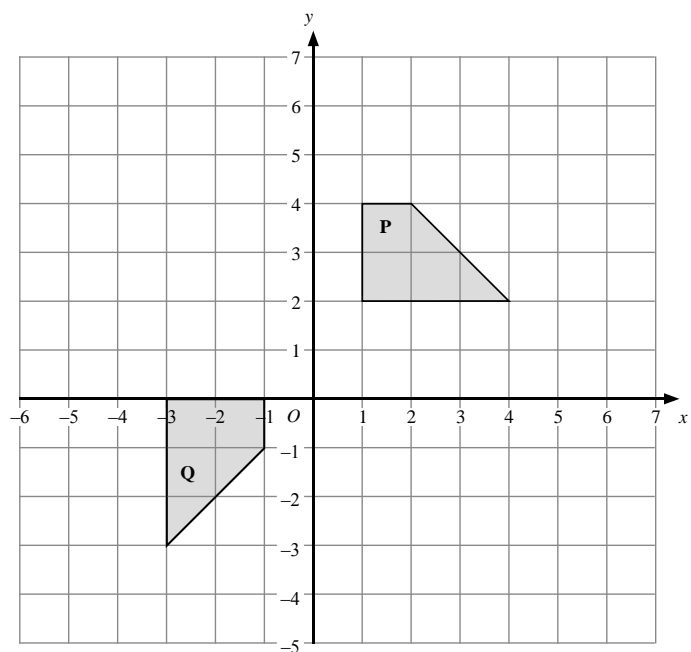

Describe fully the single transformation that will map shape **P** onto shape **Q**.

.....

.....

(Total 3 marks)

Circles

Things to remember:

- πr^2 sounds like area to me, when I need the circumference I'll just use πD .
- Read the question carefully and check if you are being asked to find circumference or area and whether they have given you the radius or the diameter.
- Remember the diameter is twice the radius.

Questions:

1. The diameter of a wheel on Harry's bicycle is 0.65 m.
Calculate the circumference of the wheel.
Give your answer correct to 2 decimal places.
Diagram NOT accurately drawn

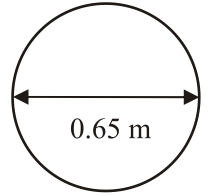

..... m
(Total 2 marks)

2. Diagram NOT accurately drawn
The radius of this circle is 8 cm.
Work out the circumference of the circle.
Give your answer correct to 2 decimal places.

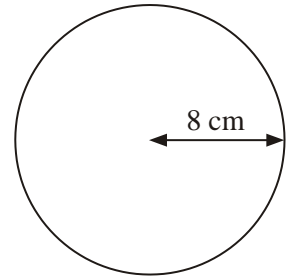

..... cm
(Total 2 marks)

3. Diagram NOT accurately drawn
The radius of the circle is 9.7 cm.
Work out the area of the circle.
Give your answer to 3 significant figures.

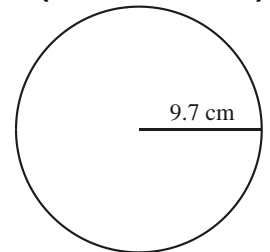

..... cm²
(Total 2 marks)

4. A circle has a radius of 6.1 cm.
Work out the area of the circle.

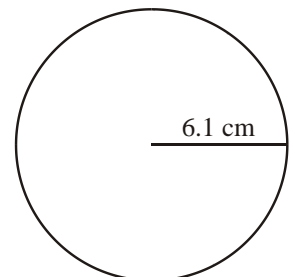

.....
(Total 3 marks)

5. The top of a table is a circle.
 The radius of the top of the table is 50 cm.
 (a) Work out the area of the top of the table.

.....cm²



(2)

- The base of the table is a circle.
 The diameter of the base of the table is 40 cm.
 (b) Work out the circumference of the base of the table.

.....cm

(2)

(Total 4 marks)

6. The diagram shows two small circles inside a large circle.
 The large circle has a radius of 8 cm.
 Each of the two small circles has a diameter of 4 cm.
 (a) Write down the radius of each of the small circles.

..... cm

(1)

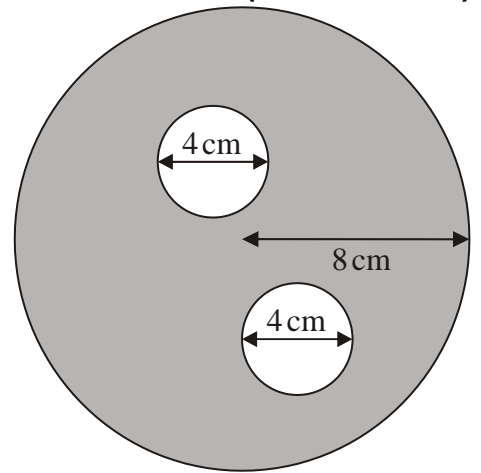

- (b) Work out the area of the region shown shaded in the diagram.
 Give your answer correct to one decimal place.

..... cm²

(4)

(Total 5 marks)

Area Problems

Things to remember:

- Area of a rectangle = base x height
- Area of a triangle = $\frac{1}{2}$ x base x height
- Area of a parallelogram = base x height
- Area of a trapezium = $\frac{1}{2}$ (a + b) h, where a and b are the parallel sides and h is the height
- The perimeter is the distance around the edge of the shape

Questions:

*1. The diagram shows the floor plan of Mary's conservatory.

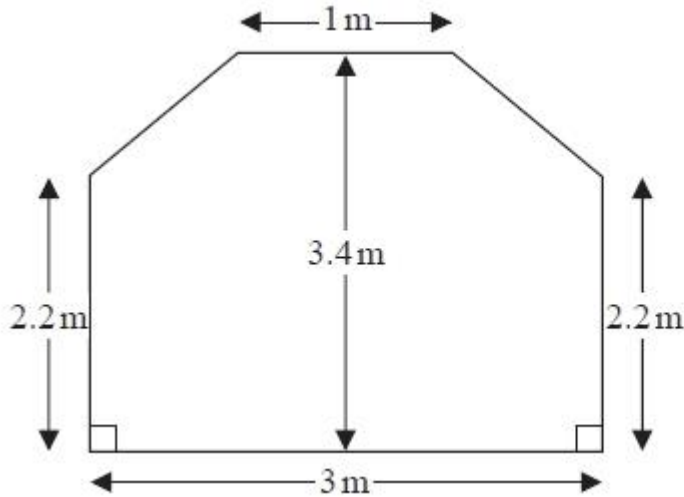

Diagram NOT
accurately drawn

Mary is going to cover the floor with tiles.

The tiles are sold in packs.

One pack of tiles will cover 2m^2

A pack of tiles normally costs £24.80

Mary gets a discount of 25% off the cost of the tiles.

Mary has £100

Does Mary have enough money to buy all the tiles she needs?

You must show all your working.

(Total for question = 5 marks)

- *2. Mr Weaver's garden is in the shape of a rectangle. In the garden there is a patio in the shape of a rectangle and two ponds in the shape of circles with diameter 3.8 m. The rest of the garden is grass.

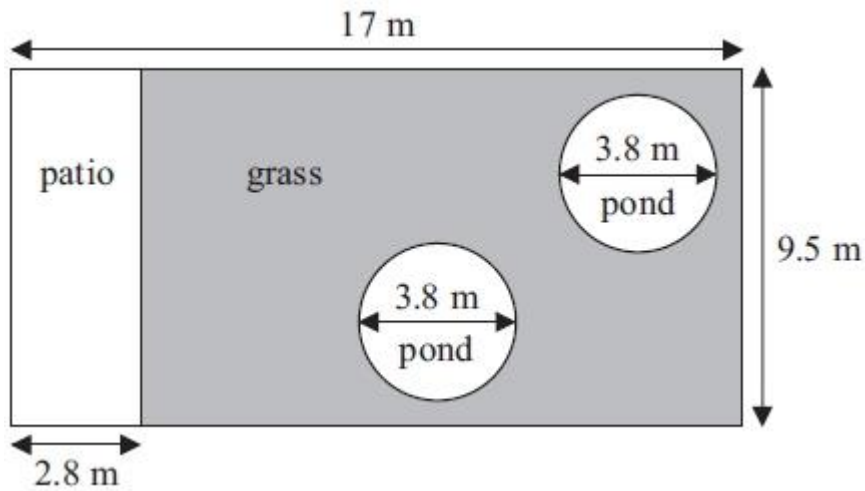
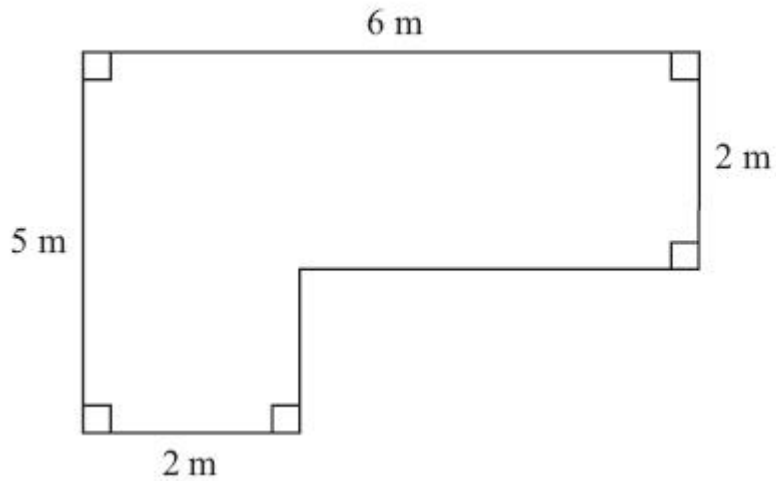

Diagram **NOT** accurately drawn

Mr Weaver is going to spread fertiliser over all the grass. One box of fertiliser will cover 25 m^2 of grass. How many boxes of fertiliser does Mr Weaver need? You must show your working.

(Total for Question is 5 marks)

- *3. The diagram shows the plan of Mrs Phillips' living room.



Mrs Phillips is going to cover the floor with floor boards.
One pack of floor boards will cover 2.5 m^2 .
How many packs of floor boards does she need?
You must show your working.

(Total for Question is 4 marks)

4. A piece of card is in the shape of a trapezium.

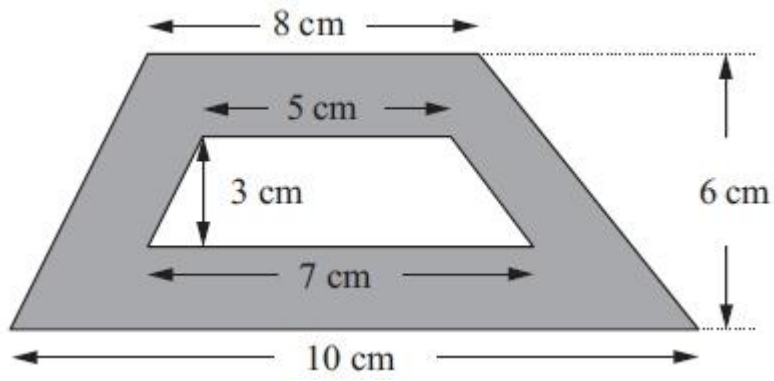

Diagram **NOT** accurately drawn

A hole is cut in the card.
The hole is in the shape of a trapezium.
Work out the area of the shaded region.

..... cm²
(Total for Question is 3 marks)

5. Mrs Kunal's garden is in the shape of a rectangle. Part of the garden is a patio in the shape of a triangle. The rest of the garden is grass.

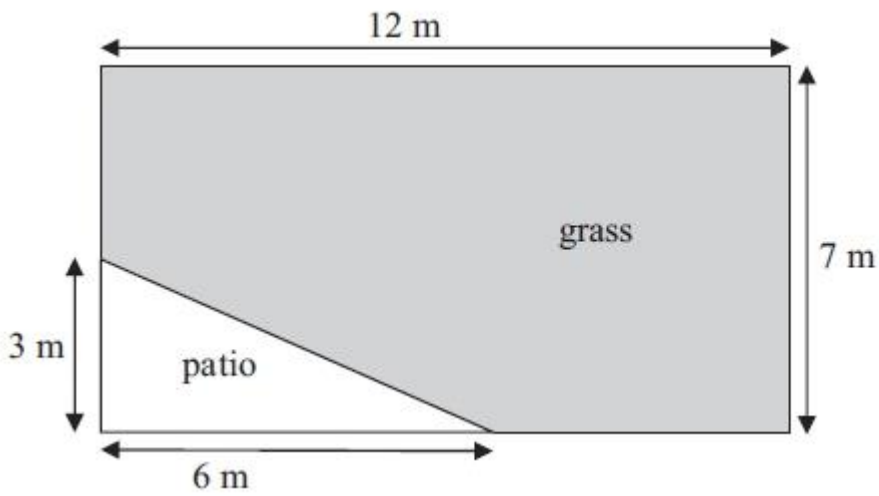

Diagram **NOT** accurately drawn

Mrs Kunal wants to spread fertiliser over all her grass. One box of fertiliser is enough for 32 m^2 of grass. How many boxes of fertiliser will she need? You must show your working.

.....
(Total for Question is 4 marks)

- *6. The diagram shows a flower bed in the shape of a circle.

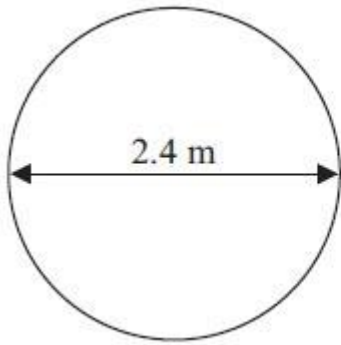

Diagram **NOT**
accurately drawn

The flower bed has a diameter of 2.4 m.

Sue is going to put a plastic strip around the edge of the flower bed.

The plastic strip is sold in 2 metre rolls.

How many rolls of plastic strip does Sue need to buy?

You must show all your working.

(Total for Question is 4 marks)

Volume and Surface Area of Prisms

Things to remember:

- Volume of a prism = area of cross section x length
- The surface area is the area of the surface (calculate the area of each face then add together)

Questions:

1. The diagram shows a prism.

All the corners are right angles.
Work out the volume of the prism.

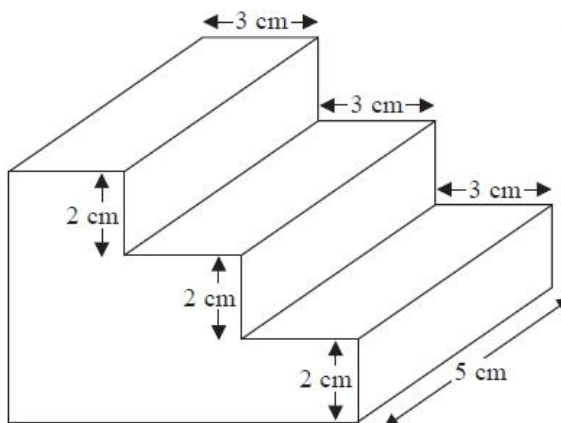

Diagram NOT accurately drawn

.....cm³
(Total for question = 3 marks)

2. The diagram shows the area of each of three faces of a cuboid.

Diagram **NOT** accurately drawn

The length of each edge of the cuboid is a whole number of centimetres.

Work out the volume of the cuboid.

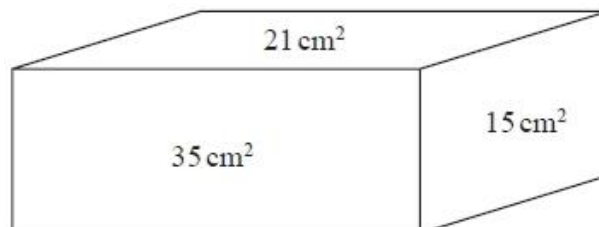

.....cm³
(Total for question = 4 marks)

3. The diagram shows a triangular prism.
Work out the volume of the prism.

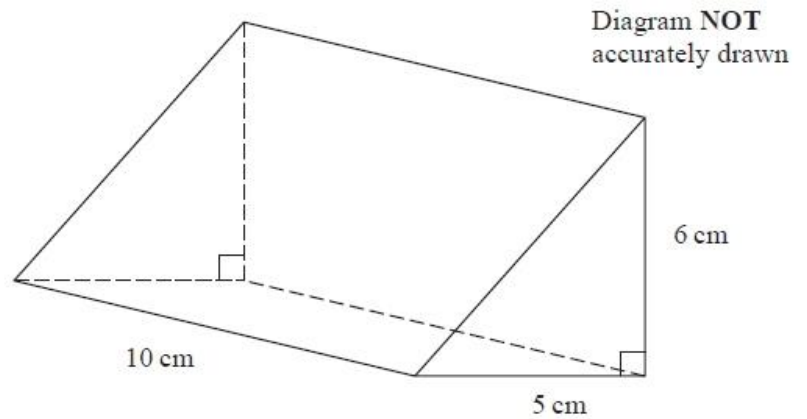

(Total for question = 3 marks)

4. A matchbox is 5 cm by 8 cm by 2 cm.
A carton is 20 cm by 40 cm by 20 cm.
The carton is completely filled with matchboxes.

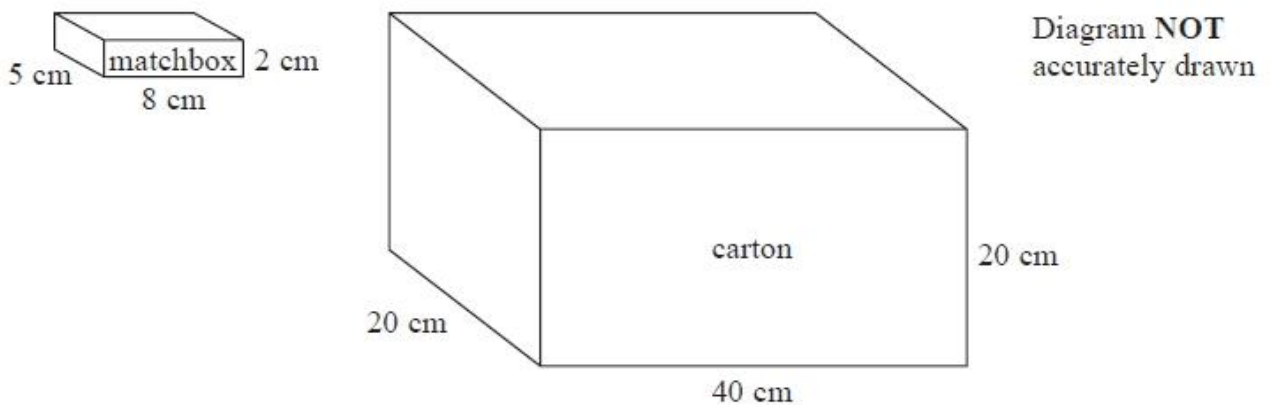

Work out the number of matchboxes in the carton.

(Total for Question is 3 marks)

5. Diagram NOT accurately drawn

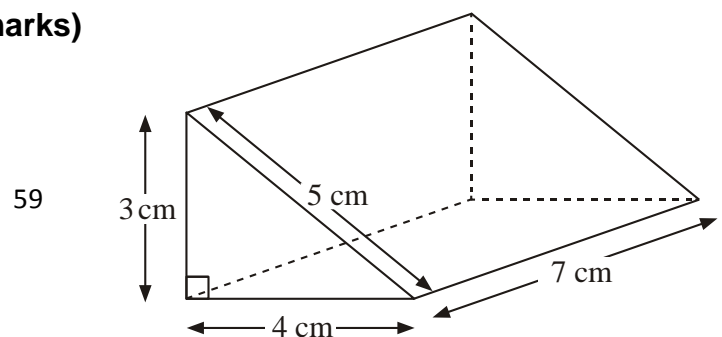

Work out the total surface area of the triangular prism.

..... cm²
(Total 3 marks)

6. The diagram shows a prism.

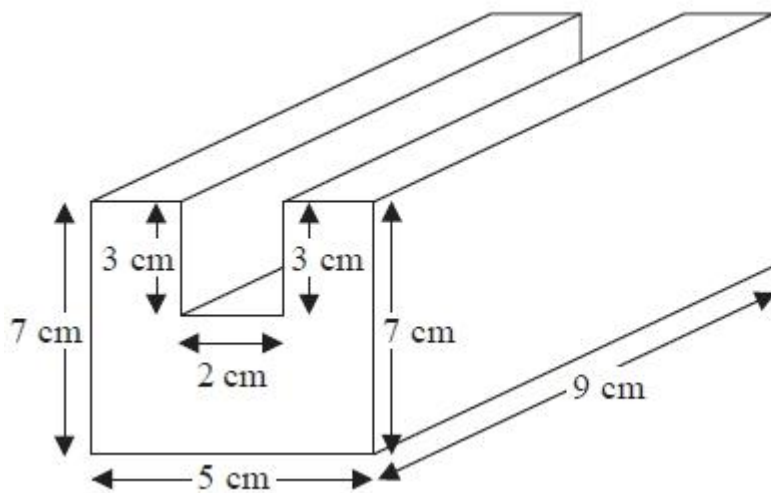

Diagram NOT accurately drawn

All the corners are right angles.
 Work out the volume of the prism.

.....cm³

(Total for question = 4 marks)

7. Diagram NOT accurately drawn
 The diagram represents a shed.

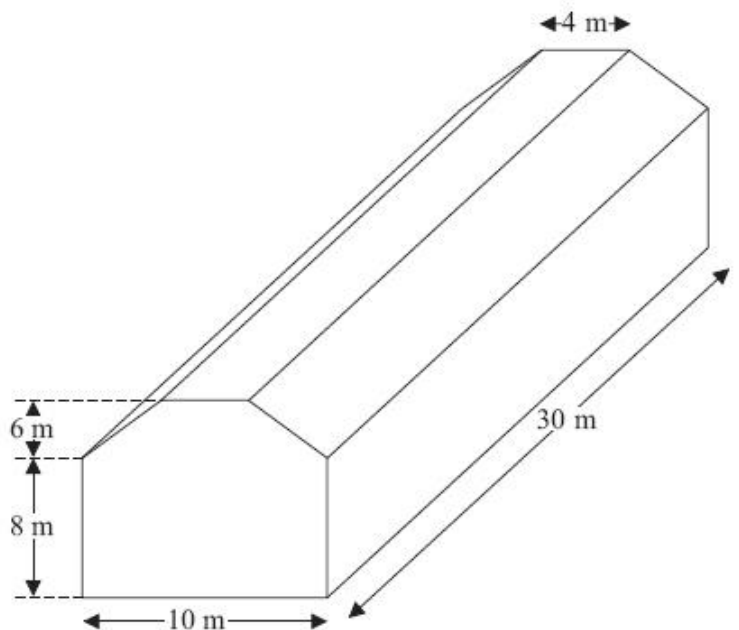

The shed is in the shape of a prism.
 The cross section of the prism is a hexagon.
 The hexagon has one line of symmetry.
 The walls of the shed are vertical.
 Calculate the volume of the shed.

.....m³
(Total for Question is 4 marks)

8. Jane makes cheese.
 The cheese is in the shape of a cuboid.

Jane is going to make a new cheese.
 The new cheese will also be in the shape of a cuboid.
 The cross section of the cuboid will be a 5cm by 5cm square.

Jane wants the new cuboid to have the same volume as the
 2cm by 10cm by 15cm cuboid.
 Work out the value of x .

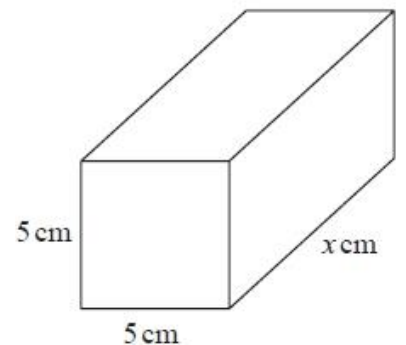
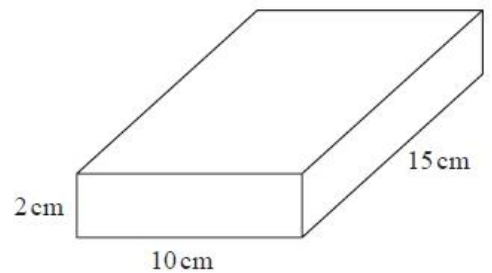

..... cm
(Total for question = 3 marks)

Speed, Distance and Time

Things to remember:

- There are 60 seconds in a minute and 60 minutes in an hour.
- 5 miles = 8 km

Questions:

1. The distance from Fulbeck to Ganby is 10 miles.
The distance from Ganby to Horton is 18 miles.

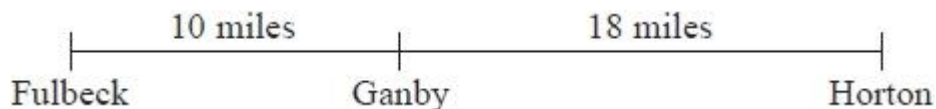

Raksha is going to drive from Fulbeck to Ganby.
Then she will drive from Ganby to Horton.
Raksha leaves Fulbeck at 10 00
She drives from Fulbeck to Ganby at an average speed of 40mph.
Raksha wants to get to Horton at 10 35
Work out the average speed Raksha must drive at from Ganby to Horton.

..... mph

(Total for question = 3 marks)

2. A London airport is 200 miles from Manchester airport.
A plane leaves Manchester airport at 10 am to fly to the London airport.
The plane flies at an average speed of 120 mph.
What time does the plane arrive at the London airport?

.....
(Total for question = 4 marks)

- *3. The world speed record for a train is 360 mph.
 It takes Malcolm 6 seconds to drive a train 1 kilometre.
 Has the train broken the world speed record?
 Use 5 miles = 8 km.

(Total for question = 5 marks)

4. *A*, *B* and *C* are 3 service stations on a motorway.
 $AB = 25$ miles and $BC = 25$ miles

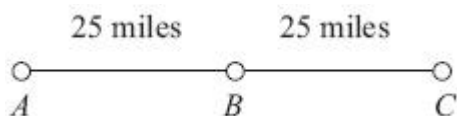

Aysha drives along the motorway from *A* to *C*.
 Aysha drives at an average speed of 50 mph from *A* to *B*.
 She drives at an average speed of 60 mph from *B* to *C*.
 Work out the difference in the time Aysha takes to drive from *A* to *B* and the time Aysha takes to drive from *B* to *C*.
 Give your answer in minutes.

..... minutes

(Total for Question is 3 marks)

5. Peter goes for a walk.
He walks 15 miles in 6 hours.
(a) Work out Peter's average speed.
Give your answer in miles per hour.

..... mph
(2)

- 5 miles = 8 km.
Sunita says that Peter walked more than 20 km.
*(b) Is Sunita right?
You must show all your working.

(2)
(Total for Question is 4 marks)

Averages

Things to remember:

- Mode is most – the number that occurs the most frequently.
- Median is middle – put the numbers in order then identify the middle number.
- Mean is mean to work out – add all the numbers together and divide by the quantity in the list.
- Range is the difference from the biggest to the smallest.

Questions:

1. Mrs Smith asked each student in her class to record the numbers of times they used their mobile phone last Saturday.

Here are the results for the boys.

Boys 8 10 8 9 7 9 8 13 14

(a) Work out the median.

.....
(2)

Here are the results for the girls.

Girls 6 8 9 9 10 14 14

*(b) Compare the numbers of times the boys used their mobile phones with the numbers of times the girls used their mobile phones.

(4)

(Total for question = 6 marks)

2. There are 18 packets of sweets and 12 boxes of sweets in a carton.
The mean number of sweets in all the 30 packets and boxes is 14
The mean number of sweets in the 18 packets is 10
Work out the mean number of sweets in the boxes.

.....
(Total for question = 3 marks)

3. 25 students in class A did a science exam.
30 students in class B did the same science exam.
The mean mark for the 25 students in class A is 67.8
The mean mark for all the 55 students is 72.0
Work out the mean mark for the students in class B.

.....
(Total for Question is 3 marks)

4. There are 10 boys and 20 girls in Mrs Brook's class.
Mrs Brook gave all the class a test.
The mean mark for all the class is 60
The mean mark for the girls is 56
Work out the mean mark for the boys.

.....
(Total for Question is 3 marks)

5. Here are four number cards.
One of the cards is turned over so you cannot see the number on it.

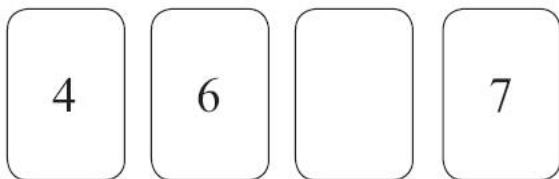

The mean of the four numbers is 6
Work out the number you **cannot** see.

.....
(Total for Question 10 is 3 marks)

- *6. There are two trays of plants in a greenhouse.
 The first tray of plants was given fertiliser.
 The second tray of plants was not given fertiliser.
 On Monday the heights of the plants were measured in centimetres.
 The boxes show some information about the heights of the plants.

Heights of the plants given fertiliser							
22	29	30	35	37	40	44	47
48	48	54	56	59	66	72	

Information about the heights of plants not given fertiliser			
Smallest	18	Lower quartile	26
Largest	64	Upper quartile	47
Median	44		

Compare the distribution of the heights of the plants given fertiliser to the distribution of the heights of the plants not given fertiliser.

(Total for Question is 4 marks)

7. 23 girls have a mean height of 153 cm.
 17 boys have a mean height of 165 cm.
 Work out the mean height of all 40 children.

..... cm
(Total for Question is 3 marks)

8. Hertford Juniors is a basketball team.
At the end of 10 games, their mean score is 35 points per game.
At the end of 11 games, their mean score has gone down to 33 points per game.
How many points did the team score in the 11th game?

.....
(Total for Question is 3 marks)

9. Mr Brown gives his class a test.
The 10 girls in the class get a mean mark of 70%
The 15 boys in the class get a mean mark of 80%

Nick says that because the mean of 70 and 80 is 75 then the mean mark for the whole class in the test is 75%
Nick is not correct.

Is the correct mean mark less than or greater than 75%?
You must justify your answer.

.....
.....
.....

(Total for question = 2 marks)

10. Walkden Reds is a basketball team.
At the end of 11 games, their mean score was 33 points per game.
At the end of 10 games, their mean score was 2 points higher.

Jordan says,
"Walkden Reds must have scored 13 points in their 11th game."

Is Jordan right?
You must show how you get your answer.

.....
(Total for question is 3 marks)

Scatter Graphs

Things to remember:

- Check the scale carefully when plotting points. If it helps, write in more numbers on the scale.
- Always draw a line of best fit
- When estimating a value show lines on your graph.
- You can describe a relationship by using the words “positive correlation” or “negative correlation.” Make sure you include the word correlation.

Questions:

1. Leon recorded the height, in cm, and the weight, in kg, of each of ten students. The scatter graph shows information about his results.

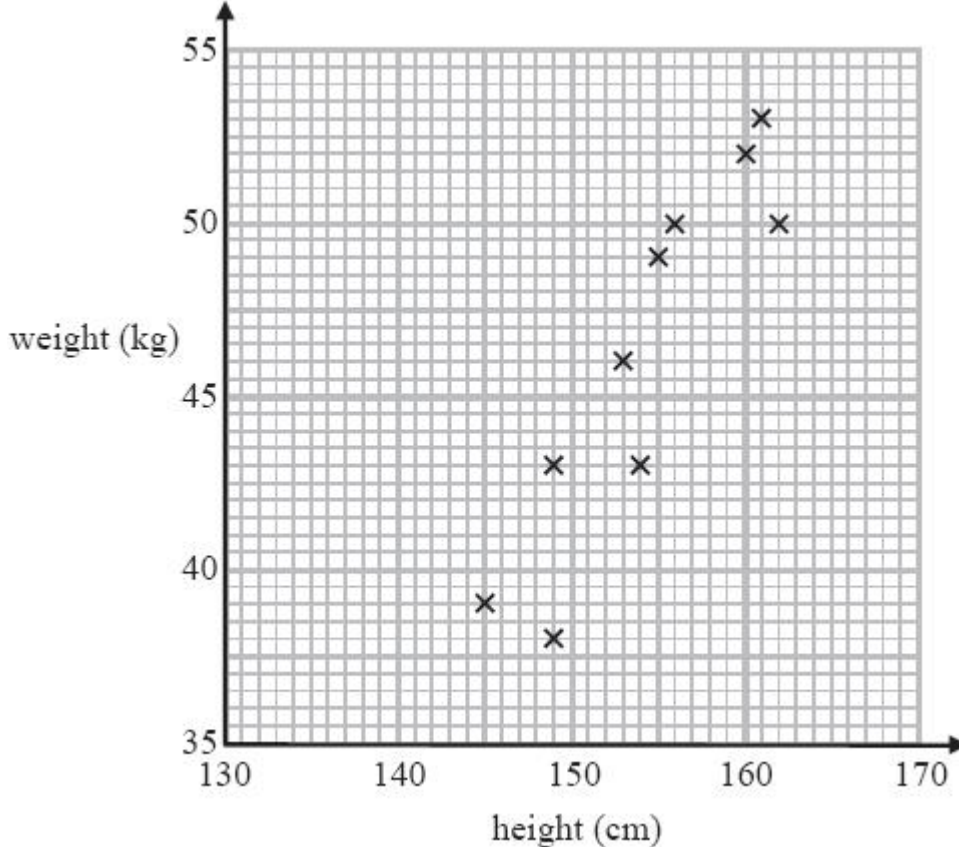

A different student has a height of 146 cm and a weight of 41 kg.

(a) Plot this information on the scatter graph.

(1)

(b) Describe the relationship between the height and the weight of these students.

..... cm
(1)

A student has a weight of 47.5 kg.

(c) Use the scatter graph to estimate the height of this student.

..... cm
(2)

(Total for question = 4 marks)

2. Bill wants to compare the heights of pine trees growing in sandy soil with the heights of pine trees growing in clay soil. The scatter diagram gives some information about the heights and the ages of some pine trees.

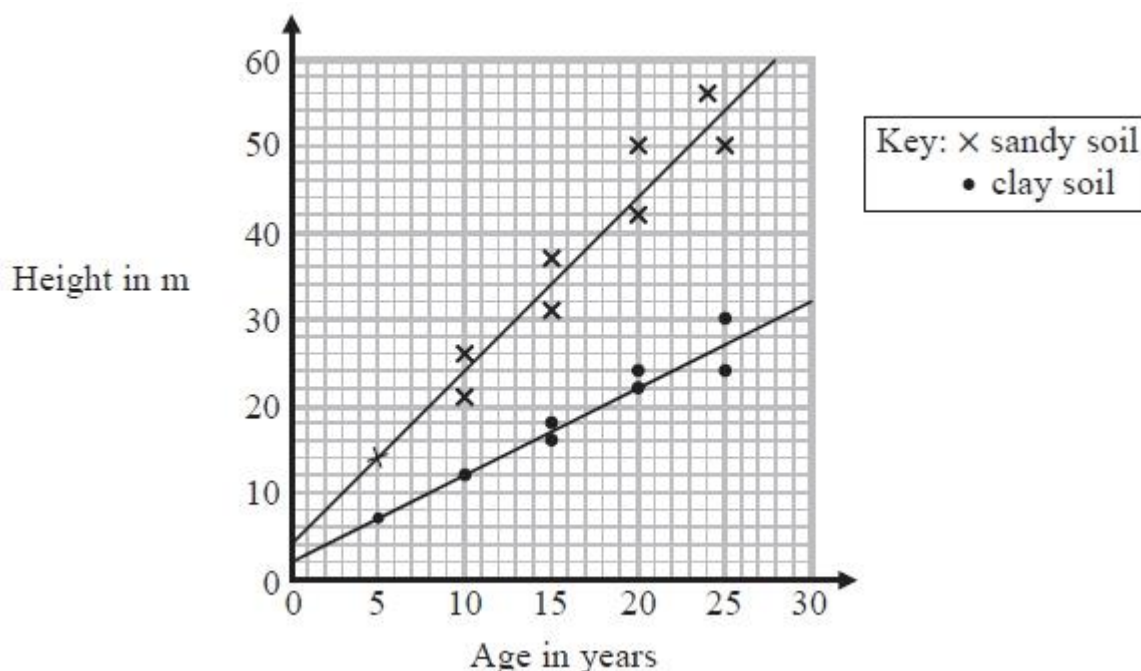

- (a) Describe the relationship between the height of pine trees and the age of pine trees growing in sandy soil.

.....
(1)

A pine tree growing in clay soil is 18 years old.

- (b) Find an estimate for the height of this tree.

.....m
(1)

A pine tree is growing in sandy soil.

- (c) Work out an estimate for how much the height of this tree increases in a year.

.....m
(2)

- (d) Compare the rate of increase of the height of trees growing in clay soil with the rate of increase of the height of trees growing in sandy soil.

.....
.....
(2)

(Total for question = 6 marks)

3. A delivery driver records for each delivery the distance he drives and the time taken. The scatter graph shows this information.

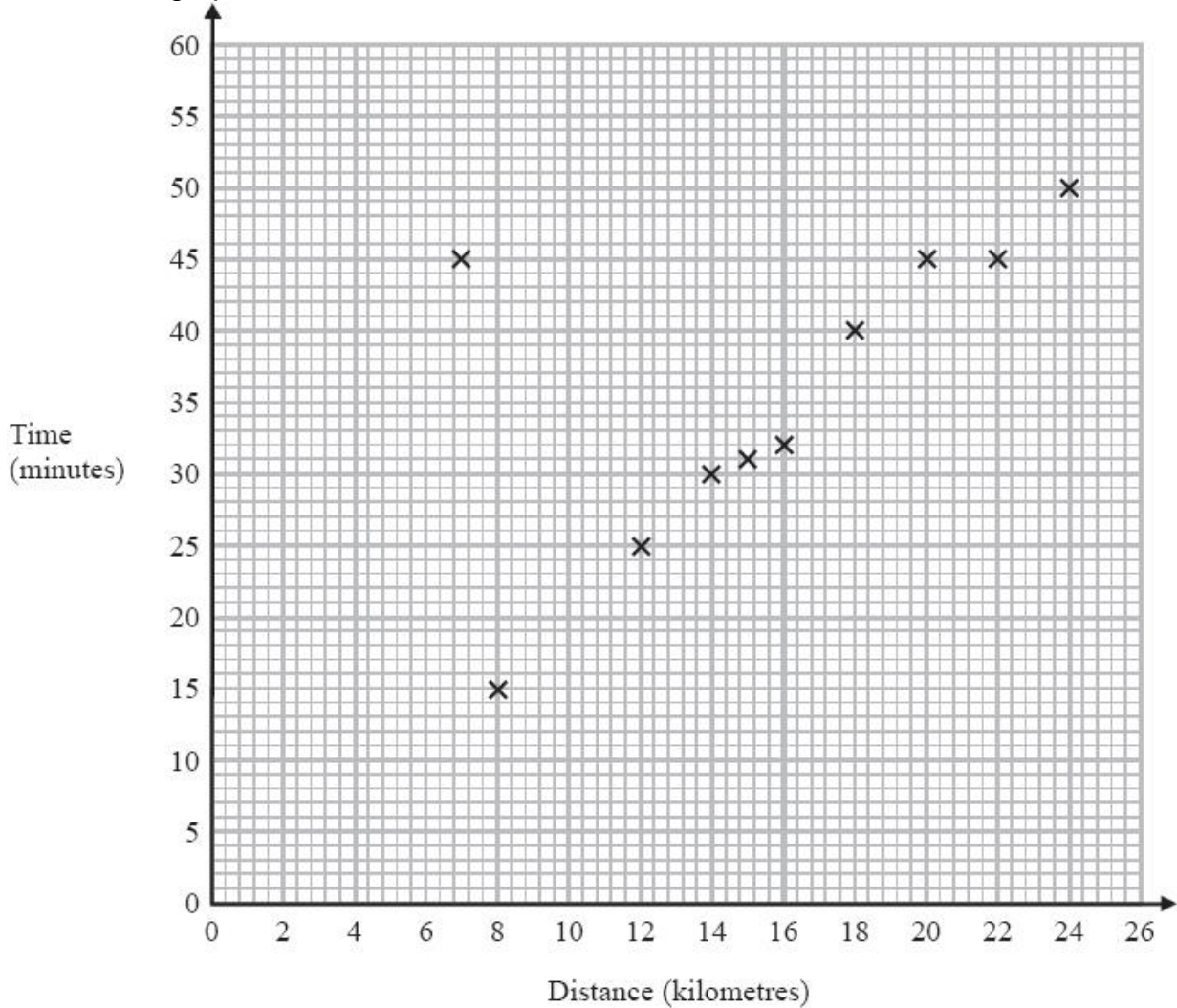

For another delivery he drives 22 kilometres and takes 50 minutes.

- (a) Show this information on the scatter graph. (1)
- (b) What type of correlation does the scatter graph show?

..... (1)

The driver has to drive a distance of 10km for his next delivery.

- (c) Estimate the time taken for this delivery.
- minutes (2)

During one of the deliveries, the driver was delayed by road works.

- (d) Using the graph write down the time taken for this delivery.
- minutes (1)

(Total for question = 5 marks)

4. Carlos has a cafe in Clacton. Each day, he records the maximum temperature in degrees Celsius ($^{\circ}\text{C}$) in Clacton and the number of hot chocolate drinks sold. The scatter graph shows this information.

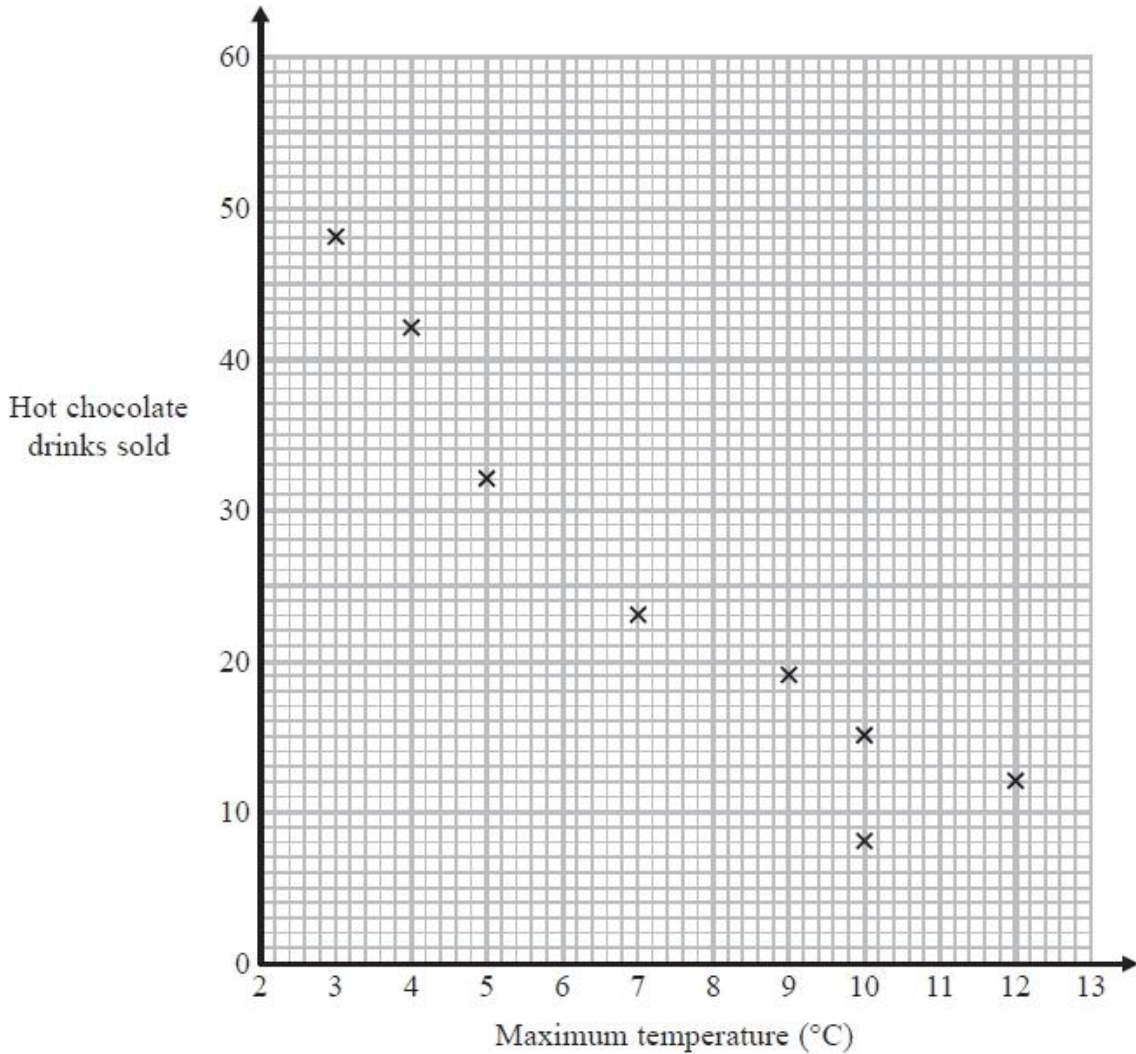

On another day the maximum temperature was 6°C and 35 hot chocolate drinks were sold.

- (a) Show this information on the scatter graph. (1)
- (b) Describe the relationship between the maximum temperature and the number of hot chocolate drinks sold.
-
- (1)
- (c) Draw a line of best fit on the scatter diagram. (1)

One day the maximum temperature was 8°C .

- (d) Use your line of best fit to estimate how many hot chocolate drinks were sold.

..... (1)

(Total for Question is 4 marks)

5. A car company records the number of miles cars of different engine sizes, in litres, travel using one gallon of fuel. The scatter graph shows this information.

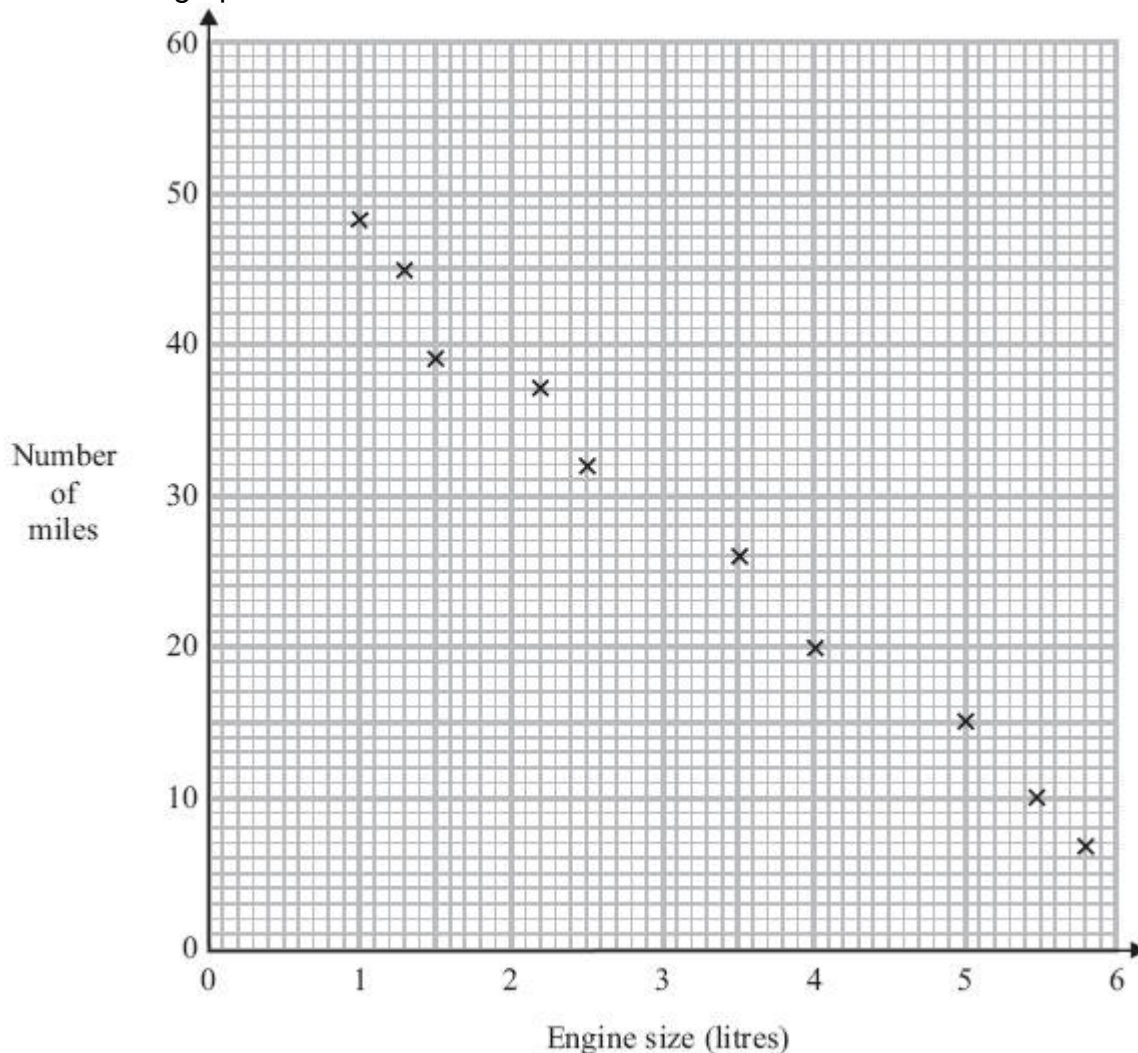

Another car has an engine size of 1.8 litres and travels 42 miles using one gallon of fuel.

- (a) Plot this information on the scatter graph. (1)
- (b) What type of correlation does this scatter graph show? (1)

..... miles (1)

- (c) Draw a line of best fit. (1)

A car has an engine size of 2.8 litres.

- (d) Find an estimate for the number of miles this car travels using one gallon of fuel.

..... miles (1)

(Total for Question is 4 marks)

6. The table shows the average temperature on each of seven days and the number of units of gas used to heat a house on these days.

Average temperature ($^{\circ}\text{C}$)	0	1	3	9	10	12	13
Units of gas used	20	16	18	10	6	6	2

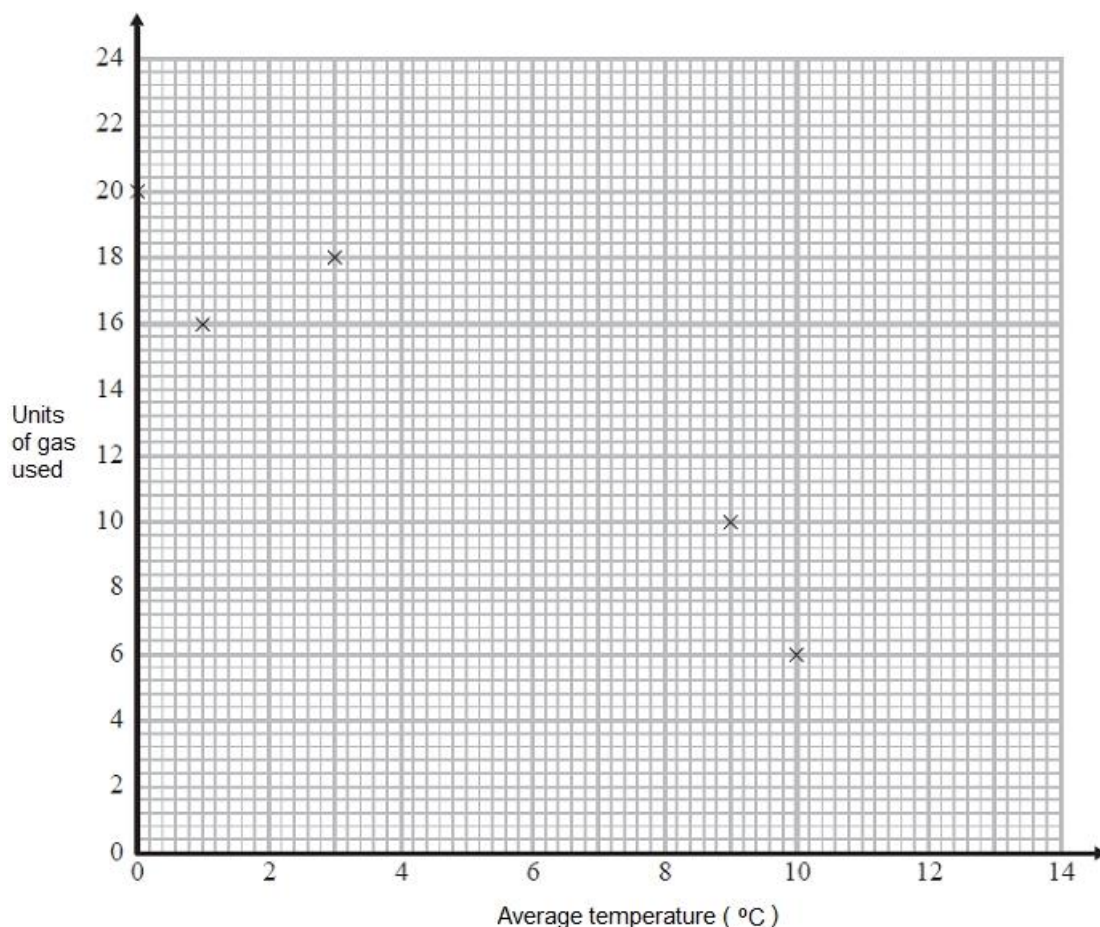

- (a) Complete the scatter graph to show the information in the table. The first 5 points have been plotted for you. (1)
- (b) Describe the relationship between the average temperature and the number of units of gas used.

.....

.....

- (c) Estimate the average temperature on a day when 12 units of gas are used. (1)

..... $^{\circ}\text{C}$

(2)

(Total for Question is 4 marks)

Relative Frequency

Things to remember:

- Probabilities of exhaustive events sum to 1
- To calculate relative frequency, multiply the number of trials by the given probability

Questions:

1. An electronic game can show red or blue or green or yellow.
The table shows the probabilities that the colour shown will be red or will be green or will be yellow.

Colour	red	blue	green	yellow
Probability	0.15		0.41	0.24

Arthur plays the game.

- (a) Work out the probability that the colour shown will be blue.

.....
(2)

Janice is going to play the game 50 times.

- (b) Work out an estimate for the number of times the colour shown will be yellow.

.....
(2)
(Total for question = 4 marks)

2. Karl wants to raise money for charity.
He designs a game for people to play.
Karl uses a fair 10-sided dice for the game.
The dice is numbered from 1 to 10
Each person will roll the dice once. A person wins the game if the dice lands on a multiple of 4
Ali plays the game once.

- (a) Work out the probability that Ali will win the game.

.....
(2)

Each person pays 30p to play the game once.

The prize for a win is £1

Karl thinks that the game will be played 100 times.

- (b) Work out an estimate for how much money Karl will raise for charity.

.....
(3)
(Total for question = 5 marks)

3. Ali throws a biased dice 200 times.
The table shows information about his results.

Score	Frequency
1	47
2	4
3	25
4	56
5	38
6	30

Charlie throws the dice 550 times.

Work out an estimate for the total number of times that Charlie will get a score of 4

.....
(Total for Question is 3 marks)

4. The probability that a pea plant will grow from a seed is 93%.
Sarah plants 800 seeds.
Work out an estimate for the number of seeds that will grow into pea plants.

.....
(Total for Question is 2 marks)

5. Rhiana plays a game.
The probability that she will lose the game is 0.32
The probability that she will draw the game is 0.05
Rhiana is going to play the game 200 times.
Work out an estimate for the number of times Rhiana will win the game.

.....
(Total for Question is 3 marks)

6. The probability that a biased dice will land on a five is 0.3
Megan is going to roll the dice 400 times.
Work out an estimate for the number of times the dice will land on a five.

.....
(Total for Question is 2 marks)

7. Here is a fair 6-sided spinner.

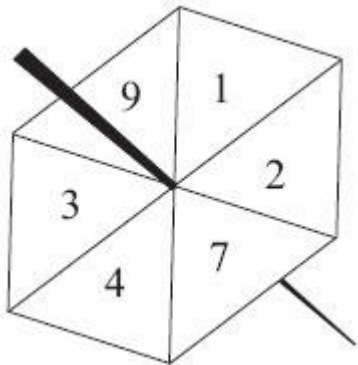

Jake is going to spin the spinner once.

(a) Write down the probability that the spinner will land

(i) on 4

.....

(ii) on a number greater than 10

.....

(2)

Liz is going to spin the spinner 120 times.

(b) Work out an estimate for the number of times the spinner will land on 7

.....

(2)

(Total for Question is 4 mark)

8. There are only red counters, blue counters, white counters and black counters in a bag. The table shows the probability that a counter taken at random from the bag will be red or blue.

Colour	red	blue	white	black
Probability	0.2	0.5		

The number of white counters in the bag is the same as the number of black counters in the bag.

Tania takes at random a counter from the bag.

(a) Work out the probability that Tania takes a white counter.

.....

(2)

There are 240 counters in the bag.

(c) Work out the number of red counters in the bag.

.....

(2)

(Total for Question is 4 marks)

Dividing into a Ratio

Things to remember:

- Start by dividing the quantity by the total number of parts, then multiply by each share.
- Don't forget to include units throughout your working.

Questions:

1. Keith and Graham share £105 in the ratio 4:3
Work out how much Keith gets.

.....
(Total for Question is 2 marks)

- *2. Talil is going to make some concrete mix.
He needs to mix cement, sand and gravel in the ratio 1 : 3 : 5 by weight.
Talil wants to make 180 kg of concrete mix.
Talil has
 15 kg of cement
 85 kg of sand
 100 kg of gravel
Does Talil have enough cement, sand and gravel to make the concrete mix?

(Total for Question is 4 marks)

3. Liam, Sarah and Emily shared some money in the ratio 2 : 3 : 7
Emily got £80 more than Liam.
How much money did Sarah get?

.....
(Total for question = 3 marks)

4. A pile of sand has a weight of 60 kg.
The sand is put into a small bag, a medium bag and a large bag in the ratio 2 : 3 : 7
Work out the weight of sand in each bag.

small bag kg

medium bag kg

large bag kg

(Total for Question is 3 marks)

5. A shop sells freezers and cookers.
The ratio of the number of freezers sold to the number of cookers sold is 5 : 2
The shop sells a total of 140 freezers and cookers in one week.
*(a) Work out the number of freezers and the number of cookers sold that week.

- Jake buys this freezer in a sale.
The price of the freezer is reduced by 20%.
(b) Work out how much Jake saves.

Freezer
Original Price
£145



(3)

£

(2)

(Total for Question is 5 marks)

6. Graham and Michael share £35 in the ratio 5 : 2
Work out the amount of money that Graham gets.

£

(Total for Question is 2 marks)

7. 5 schools sent some students to a conference.
One of the schools sent both boys and girls.
This school sent 16 boys.
The ratio of the number of boys it sent to the number of girls it sent was 1 : 2
The other 4 schools sent only girls.
Each of the 5 schools sent the same number of students.
Work out the total number of students sent to the conference by these 5 schools.

.....
(Total for Question is 4 marks)

Recipes

Things to remember:

- Calculate the scale factor.
- Multiply each ingredient by the scale factor.
- Check your answer using estimating and common sense to check that it seems sensible.

Questions:

1. This is a list of ingredients for making a pear & almond crumble for 4 people.

Ingredients for **4**
people.
80 g plain flour
60 g ground almonds
90 g soft brown sugar
60 g butter
4 ripe pears

Work out the amount of each ingredient needed to make a pear & almond crumble for **10** people.

..... g plain flour

..... g ground almonds

..... g soft brown sugar

..... g butter

..... ripe pears

(Total 3 marks)

2. Here are the ingredients needed to make 500 ml of custard.

Custard
makes 500 ml
400 ml of milk
3 large egg yolks
50 g sugar
2 teaspoons of
cornflour

(a) Work out the amount of sugar needed to make 2000 ml of custard.

.....g
(2)

(b) Work out the amount of milk needed to make 750 ml of custard.

.....ml
(2)
(Total 4 marks)

3. Here is a recipe for making 10 chocolate chip cookies.

Chocolate Chip Cookies
Makes 10 cookies.
100 g of flour
60 g of sugar
50 g of margarine
40 g of chocolate chips
2 eggs

Work out the amounts needed to make 15 chocolate chip cookies.

..... g of flour
..... g of sugar
..... g of margarine
..... g of chocolate chips
..... eggs
(Total 3 marks)

4. Here is a list of ingredients for making a peach dessert for 6 people.

Peach dessert for 6 people.
150 g jelly
10 sponge fingers
500 ml custard
200 g peaches

Bob is going to make a peach dessert for 15 people.
Work out the amount of each ingredient he needs.

.....g jelly
.....sponge fingers
.....ml custard
.....g peaches
(Total for Question is 3 marks)

5. Here are the ingredients needed to make leek and potato soup for 4 people.

<p style="text-align: center;">Leek and potato soup</p> <p style="text-align: center;">Serves 4</p> <p>4 leeks</p> <p>350 g potatoes</p> <p>600 ml vegetable stock</p> <p>300 ml milk</p>

Jenny wants to make soup for 6 people.
Work out the amount of each ingredient she needs.

..... leeks

..... g potatoes

..... ml vegetable stock

..... ml milk

(Total for question = 3 marks)

6. Jane made some almond biscuits which she sold at a fête.

She had:

5 kg of flour

3 kg of butter

2.5 kg of icing sugar

320 g of almonds

Here is the list of ingredients for making 24 almond biscuits.

<p style="text-align: center;">Ingredients for 24 almond biscuits</p> <p>150 g flour</p> <p>100 g butter</p> <p>75 g icing sugar</p> <p>10 g almonds</p>
--

Jane made as many almond biscuits as she could, using the ingredients she had.
Work out how many almond biscuits she made.

(Total for question = 3 marks)

Percentages of Amounts, Increasing and Decreasing

Things to remember:

- “Per cent” means “out of 100”.
- Increase means the value will go up, decrease means the value will go down.

Questions:

1. David is going to buy a cooker.
The cooker has a price of £320
David pays a deposit of 15% of the price of the cooker.
How much money does David pay as a deposit?

£

(Total for Question is 2 marks)

2. Work out 65% of 300

.....

(Total for question = 2 marks)

- *3. Barak is going to buy 550 nails from one of these companies.

<p>Nail Company</p> <p>50 nails</p> <p>£4.15 plus VAT at 20%</p>

<p>Hammer Company</p> <p>25 nails</p> <p>£2.95</p> <p>Special offer Buy 100 get 25 free</p>
--

He wants to buy the nails at the cheaper cost.

Where should he buy the nails, from the Nail Company or the Hammer Company?

(Total for question = 5 marks)

4. Greg sells car insurance and home insurance.
The table shows the cost of these insurances.

Insurance	car insurance	home insurance
Cost	£200	£350

Each month Greg earns
 £530 basic pay
 5% of the cost of all the car insurance he sells
 and 10% of the cost of all the home insurance he sells
 In May Greg sold
 6 car insurances
 and 4 home insurances
 Work out the total amount of money Greg earned in May.

£
(Total for Question is 5 marks)

5. Mr Watkins needs to buy some oil for his central heating.
 Mr Watkins can put up to 1500 litres of oil in his oil tank.
 There are already 850 litres of oil in the tank.
 Mr Watkins is going to fill the tank with oil.
 The price of oil is 67.2p per litre.
 Mr Watkins gets 5% off the price of the oil.
 How much does Mr Watkins pay for the oil he needs to buy?

£
(Total for Question is 5 marks)

- *6. Jim's pay is £180 each week.
Jim asks his boss for an increase of £20 a week.
Jim's boss offers him a 10% increase.
Is the offer from Jim's boss more than Jim asked for?
You must show your working.

(Total for Question is 3 marks)

- *7. Gordon owns a shop.
Here are the prices of three items in Gordon's shop and in a Supermarket.

Gordon's Shop	
400 g loaf of bread	£1.22
1 litre of milk	£0.96
40 tea bags	£2.42

Supermarket	
400 g loaf of bread	£1.15
1 litre of milk	£0.86
40 tea bags	£2.28

Gordon reduces his prices by 5%.
Will the total cost of these three items be cheaper in Gordon's shop than in the Supermarket?

(Total for Question is 3 marks)

8. Mr Brown and his 2 children are going to London by train.
An adult ticket costs £24
A child ticket costs £12
Mr Brown has a Family Railcard.

Family Railcard gives

$\frac{1}{3}$ off adult tickets

60% off child tickets

Work out the total cost of the tickets when Mr Brown uses his Family Railcard.

£.....
(Total for Question is 4 marks)

Fractions, Decimals and Percentages

Things to remember:

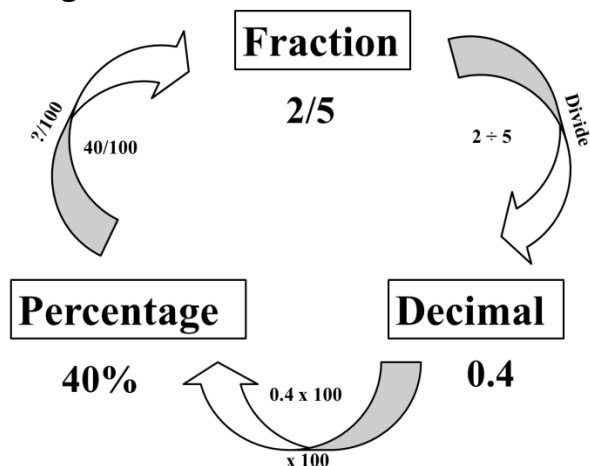

Questions:

1. (a) Write 0.1 as a fraction.

..... (1)

(b) Write $\frac{1}{4}$ a decimal.

..... (1)

(Total for Question is 2 marks)

2. (a) Write $\frac{3}{4}$ as a decimal.

..... (1)

(b) Write 0.3 as a fraction.

..... (1)

(Total for Question is 2 marks)

3. (a) Write $\frac{1}{4}$ as a decimal.

..... (1)

(b) Write 0.15 as a fraction.

..... (1)

(c) Write 17 out of 40 as a fraction.

..... (1)

(Total for question = 3 marks)

4. (a) Write $\frac{7}{10}$ as a decimal.

 (1)
- (b) Write 0.45 as a percentage.

 (1)
- (c) Write 30% as a fraction.
 Give your fraction in its simplest form.

 (2)
- (Total for Question is 4 marks)**

5. (a) Write 0.7 as a fraction.

 (1)
- (b) Write 0.3 as a percentage.

 (1)
- (c) Write $\frac{8}{12}$ in its simplest form.

 (1)
- (Total for Question is 3 marks)**

6. Write these numbers in order of size. Start with the smallest number.
 75% $\frac{7}{8}$ 0.25 $\frac{1}{2}$ $\frac{2}{3}$
-
- (Total for question = 2 marks)**

7. Write these numbers in order of size. Start with the smallest number.
 0.6 $\frac{2}{3}$ 65% 0.606
-
- (Total for question = 2 marks)**

8. Celina and Zoe both sing in a band.
One evening the band plays for 80 minutes.
Celina sings for 65% of the 80 minutes.

$$\frac{5}{8}$$

Zoe sings for $\frac{5}{8}$ of the 80 minutes.
Celina sings for more minutes than Zoe sings.
Work out for how many more minutes.
You must show all your working.

..... minutes
(Total for question = 4 marks)

Useful websites:

www.mathswatchvle.com

(Video explanations and questions)

Centre ID: twgash

Username: firstname

Password: lastname

www.methodmaths.com

(Past papers online that get instantly marked)

Centre ID: wga

Username: firstname

Password: lastname

www.hegartymaths.com

(Online tutorials and quizzes)

Login: first name and last name are backwards and
case sensitive

**[www.bbc.co.uk/schools/gcsebitesize
/maths](http://www.bbc.co.uk/schools/gcsebitesize/maths)**

Remember: Do your best;
it is all you can do 😊